

Schedules

Cafe
Di Manno
Cafe
CA Starbuck. The Signature Brand
OPEN
BREAKFAST
Big breakfast
Omelette
100% T/A Organic
Coffee
LUNCH & DINNER
Pasta
Seafood
Steak
Risotto
LICENCED



Schedules

Contents

Schedule 1 — Advertising and Notification		
Superseded and replaced by the Community Participation Plan 2019		
<hr/>		
Schedule 2		S2-1
Information required in a Development Application		
<hr/>		
Schedule 3		S3-1
Late Night Trading		
<hr/>		
3.1	Late Night Trading Area Character Statements	S3-1
3.1.1	Late Night Management Areas – Character Statement	S3-1
3.1.2	City Living Area – Character Statement	S3-3
3.1.3	Local Centre Areas – Character Statement	S3-4
<hr/>		
3.2	Plan of management requirements	S3-7
<hr/>		
Schedule 4		S4-1
Projections over or into public road		
<hr/>		
Schedule 5		S5-1
Public open space dedication and design criteria		
<hr/>		
Schedule 6		S6-1
Signage in The Rocks		
<hr/>		
6.1	A – Facades to narrow streets, lanes and passages	S6-2
6.1.1	A – Technical Drawing	S6-2
<hr/>		
6.2	B – Facades to wide streets	S6-3
6.2.1	B – Technical Drawing	S6-4
<hr/>		
6.3	C – Terraces with party walls	S6-4
6.3.1	C – Technical Drawing	S6-5
<hr/>		
6.4	D – Terraces with cantilevered balconies	S6-6
6.4.1	D – Technical Drawing	S6-6
<hr/>		
6.5	E – Shopfronts	S6-7
6.5.1	E – Technical Drawing	S6-7
<hr/>		
6.6	F – Awnings and fascias	S6-8
6.6.1	F – Technical Drawing	S6-8

6.7	G – Restaurant menus	S6-9
6.7.1	G – Technical Drawing	S6-9
6.8	H – Removable/temporary signage	S6-10
6.8.1	H – Technical Drawing	S6-11
6.9	I – Construction site hoardings	S6-11
6.10	J – Tall buildings	S6-12
6.11	K – Major multiple tenancy buildings	S6-13
6.11.1	K – Technical Drawing	S6-14
6.12	Specification Note 1	S6-14
6.12.1	General Fixing Notes	S6-14
6.12.2	Masonry Fixing Notes	S6-15
6.13	Specification Note 2	S6-15
6.14	Specification Note 3	S6-16
Schedule 7		S7-1
Transport, parking and acces		
7.1	Introduction	S7-1
7.2	Managing transport demand	S7-2
7.3	Transport report requirements	S7-2
7.4	Transport Impact Study requirements	S7-2
7.5	The requirements for a Parking and Access Report	S7-4
7.5.1	Assessment of the appropriate provision of on-site car parking	S7-5
7.5.2	Assessment of the appropriate provision for buses and coaches	S7-5
7.5.3	Assessment of the appropriate provision for mechanical parking installations	S7-6
7.6	Green Travel Plan requirements	S7-6
7.6.1	Monitoring and review mechanisms	S7-6
7.6.2	Implementation	S7-7
7.7	Transport Access Guide requirements	S7-7

7.8	Required parking spaces and design	S7-8
7.8.1	Service vehicles	S7-8
7.8.2	Buses and coaches	S7-9
7.8.3	Passenger pick up and set down areas	S7-9
7.8.4	Motorcycle parking spaces	S7-9
7.8.5	Accessible car parking spaces	S7-9
Schedule 8		S8-1
Tree management		
8.1	Neighbour notification	S8-1
8.2	Arborist reports	S8-1
8.2.1	Aboricultural Impact Assessment Report	S8-1
8.2.2	General Arborist Report	S8-1
Schedule 9		S9-1
Green roofs and walls		
9.1	Introduction	S9-1
9.2	Definitions	S9-2
9.3	Design considerations	S9-3
9.4	Information required to be submitted with a development application	S9-5
Schedule 10		S10-1
Providing community infrastructure in Green Square		
10.1	Introduction	S10-1
10.2	Why is community infrastructure needed in Green Square	S10-1
10.3	Defining community infrastructure	S10-2
10.4	How is the appropriate community infrastructure identified	S10-2
10.5	How is the value of the “equivalent” community infrastructure assessed	S10-3
10.6	How is the commitment to provide community infrastructure secured	S10-4

Schedule 11		S11-1
Electronic variable content advertising structures		
11.1	Guidelines for a Visual Impact Assessment report	S11-1
11.2	Guidelines for a Light Impact Assessment report	S11-4
11.3	Measurement of Luminance	S11-6
11.4	Times for daylight hours, twilight hours and night time hours by calendar month	S11-7
11.5	Guidelines for a Road Safety report	S11-7
Schedule 12		S12-1
Procedures for demonstrating compliance with variation provisions for street frontage height and setbacks, side and rear setbacks, building separations and tapering controls in Central Sydney		
12.1	Procedure A	S12-2
Minimum Street Setback Encroachment and Compensating Recess		
12.2	Procedure B	S12-5
Equivalent or improved wind comfort and wind safety and daylight levels in adjacent Public Places		

Schedule 2

Information required in a Development Application

A development application is to include all the relevant information as required by the "Application for Development Form". This form is available on the City of Sydney website at www.cityofsydney.nsw.gov.au.

Statement of Environmental Effects

A Statement of Environmental Effects (SEE) is required to be submitted with every development application. The purpose of the Statement of Environmental Effects is to demonstrate:

- (a) how the development is consistent with the principles of the locality statements;
- (b) the impact of the development on the public domain;
- (c) how the development will minimise any environmental impact;
- (d) how the proposal complies with *Sydney LEP 2012*, *Sydney DCP 2010* and other relevant Council codes and policies.

The SEE is to include an analysis of the development context and, where relevant, is to include detailed reports for the following;

- (a) Existing situation;
- (b) Proposed development;
- (c) Response to urban context;
- (d) Heritage implications;
- (e) Transport impact (Schedule 7);
- (f) Parking and access (Schedule 7);
- (g) Green travel plan (Schedule 7);
- (h) Transport access guide (Schedule 7);
- (i) Tree management;
- (j) Reflectivity;
- (k) Privacy impact;
- (l) Floor space area and floor space ratio calculations;
- (m) Wind effects;
- (n) Shadow assessment;
- (o) Noise effects;
- (p) Waste management;
- (q) Stormwater management;
- (r) Energy efficiency;
- (s) Construction effects;
- (t) Daylight to residential units;
- (u) Public art provision;
- (v) Response to Section 79C of the *Environmental Planning and Assessment Act 1979*; and
- (w) Copy of the land title highlighting encumbrances.

Schedule 3

Late Night Trading

3.1

Late Night Trading Area Character Statements

The Late Night Trading Management provisions identify a hierarchy of three late night trading areas located throughout the City of Sydney. These primarily include areas that are focal points for varied night-time social and recreational activity; or are, at least in part, places with a distinct night-time entertainment character; or where a night-time entertainment character is evolving, and the area is considered to have the capacity for an increase in late night activity.

There are three types of late night trading areas:

- Late Night Management Areas;
- City Living Areas; and
- Local Centre Areas.

A character statement for each is below. Late Night Trading areas are shown on the Late Night Trading Areas Map.

3.1.1 Late Night Management Areas – Character Statement

Key defining elements

Late Night Management Areas are places within the City that:

- have historically been the focal points for varied late night social and recreational activity; or
- are places with a distinct late night entertainment character; or
- have an evolving night entertainment character and the Area is considered by the Council to have the capacity for an increase in late night trading premises; or
- are business only zones, able to accommodate performance and arts and cultural uses, with good accessibility to public transport.

These places should be vibrant and multifunctional places where people can go out late at night in safety without affecting the amenity of nearby residents. Patrons of late night trading premises should be able to take advantage of a diverse range of cultural and entertainment opportunities in close proximity to each other; without one particular type of late night use dominating which may usurp the diversity and attraction of the area.

Late Night Management Areas are often regional 'destinations' that have accessible and frequent public transport at night and usually have their focus on main streets or tourist locations where people shop, meet, work and live. Given the likely higher level of visitation and the possibility of long trading hours, it is important that all premises, especially those high impact premises are well-managed and regulated.

Some Late Night Management Areas, such as the North Alexandria heritage area, will be in business only zones, with industrial buildings, ideally suited to provide space for performance, creative and cultural uses, and with good access to public transport. These business areas provide a unique opportunity for live entertainment and cultural uses without a conflict in land use, character or impact on residential amenity.

Buffer zones

Late Night Management Areas may be of variable size and their physical boundary is defined by clear transitions in the intensity and duration of late night activity compared to lower impact late night trading areas nearby. Late Night Management Areas often share boundaries with places where less intensive night-time activity is evident, such as Local Centre or City Living Areas (i.e. lower intensity classifications of late night trading).

These lower intensity areas act as buffer zones to the more concentrated late night time activity of Late Night Management Areas. Buffer zones are intended to function as a transition zone by providing a lesser intensity of use. These are not 'spill' zones, and are not intended for expansion of Late Night Management Areas.

Mix of uses

Late Night Management Areas should be vibrant places both day and night, and premises that trade late at night should enhance this vibrancy. The predominant night-time uses in Late Night Management Areas include:

- cafes
- shops
- businesses offering local services, for example: hairdressers and drycleaners
- small bars
- bars
- licensed hotels;
- theatres and performance, creative or cultural space
- restaurants; and
- other like premises.

Many of these premises may trade in the early hours of the morning, particularly on weekends.

The Late Night Trading Management provisions aim to achieve a mix of premises in Late Night Management Areas that reinforce the landmark night-time qualities of the area and which capitalise on night-time attractiveness to encourage tourism and economic activity. New premises in Late Night Management areas should contribute to diversity rather than usurp it. At the same time, new late night trading premises should not erode the diversity of retail and local services that operate during the day which service the local community, workers and visitors.

Late Night Management Areas should be places that people visit for a number of reasons and not solely to patronise high impact licensed premises such as pubs and nightclubs. Late Night Management Areas provide opportunities for late night entertainment and have historically been a focus for live music, theatre and electronic and dance music. They are appropriate places for the nurturing of performing arts and other cultural and social activities.

Issues and management

Due to the concentration of late night trading premises in Late Night Management Areas, the cumulative noise levels, generation of pedestrian and vehicle traffic, and activity levels will be an issue, more so than in other late night trading areas.

Whilst it is acknowledged that noise and late night activity is a key characteristic

of these areas, it is also essential to manage the cumulative impacts of late night trading premises in Late Night Management Areas and to effectively manage each individual late night premises within the area.

Since Late Night Management Areas may be destinations for people that live outside the City of Sydney, particularly on weekends, it is important that this higher visitation is managed effectively in order to minimise the impacts of late trading premises on nearby uses. It is important that proposals for late high impact premises such as hotels and night-clubs premises are accompanied by detailed Plans of Management which effectively address amenity, safety and security.

Trading hours

Extended hours can allow Late Night Management Areas to reinforce their role as centres of activity which offer entertainment, social and cultural opportunities that attract both locals and international visitors. Early morning trading hours may be acceptable for premises located in Late Night Management Areas where proponents can verify over time that noise, safety and amenity impacts can be managed to a level which is at an acceptable community standard. Up to 24 hour trading may be permissible in Late Night Management Areas; but only in circumstances where applicants have a sustained track record of good management, minimising amenity and safety impacts.

3.1.2 City Living Area – Character Statement

Key defining elements

This area is characterised by its diversity and potential to accommodate a range of lower impact late night trading premises which can cater to the entertainment and cultural needs of people that live in, work in and visit the City Centre.

Late night trading premises that are desirable in the City Living Area are premises that reinforce the rich cultural life of the City, establish places of interest and provide for the cosmopolitan needs of the community.

However, concentrations of late night trading premises are not encouraged, particularly when they are located in close proximity to places where the primary land use is residential in character. The City Living Area requires a lower scale and intensity of late night trading premises in comparison to Late Night Management Areas.

The City Living Area includes places where previous approvals have enabled late night trading to occur up to 24 hours a day, particularly on weekends. However, extended hours are dependent on context and impact, and in cases where impacts on residential properties cannot be effectively managed, late night trading will be limited to a narrower range of trading hours. It is desirable that premises do not trade exclusively at night and also function as places that people go during the day to create a balance of activity.

Pockets of night-time activity are encouraged in streets and laneways which are underutilised at night and where impacts on residential uses (if in close proximity) can be effectively managed. Late night trading in such places is only desirable if:

- (a) the safety of patrons and others is protected;
- (b) there are clear and safe linkages to city streets that are active at night;
- (c) public transport is frequent and accessible late at night; and
- (d) any adverse impacts on any nearby/surrounding residential development are adequately managed.

Mix of uses and concentration

The City Living Area accommodates a wide range of commercial, retail, cultural, tourism and entertainment uses with wide variations in operating hours, with many premises operating late at night throughout the week.

This area includes areas with concentrations of apartment buildings and other residential development in close proximity to existing areas of night time activity (eg. Broadway). High levels of pedestrian and vehicular activity is evident in the City Living Area at night and it broadly has a 'dual identity', with parts that contain either predominantly business or predominantly residential uses.

The potential for clustering or concentration of late night trading premises is limited in much of the City Living Area due to constraints arising from existing business and residential development that physically dominate some parts of the Area.

The City Living Area can accommodate discrete night-spots that may provide an alternative experience to the types of late night trading premises that locate elsewhere in the City.

Such night spots may range from hotels and night-clubs to small cafes that may attract clientele on the basis of reputation and prior knowledge rather than a 'critical mass' of people (or simply from passing pedestrian traffic) that visit a particular area for its high cultural and entertainment profile. Hence, due to the mixed character of the City Living Area, opportunities may exist for a diverse range of unique 'niche' premises.

Both niche and 'conventional' market premises are encouraged in the City Living Area, particularly in cases where they promote Central Sydney's role as Australia's principal centre for culture, entertainment and tourism.

Issues and management

The central issue for this Area is the management of impacts on residential development within and near the Area. As a result, proposals will differ based on whether there is nearby or surrounding residential development to the proposed premises. Plans of management will assist in this regard, as aside from the basic content they may also nominate specific mechanisms to manage proximity to residential development where appropriate.

Trading hours

Appropriate late night trading hours for premises are dependent on the extent and proximity of residential premises to any proposal. Decisions on appropriate late night trading hours will be based on the impact it is considered that the use will have on the amenity of residential and other land uses.

Generally longer trading hours may be acceptable where the predominant surrounding land use is non-residential or is insulated/protected from late night trading activity, or where there are clear buffers. Longer trading hours may be acceptable in peak periods on weekends and during special events and may be subject to trial periods as is the case for all types of late night trading land uses addressed by Council's Late Night Trading Management provisions.

Conversely, trading hours will be shorter where the predominant surrounding character is residential. Due to the generally active character in the City Living Area (even within some predominantly residential areas), longer trading hours may be considered more acceptable compared to Local Centre Trading Areas where the interface between residential and non residential uses is more defined.

3.1.3 Local Centre Areas – Character Statement

Key defining elements

Local Centre Areas are primarily located within shopping streets and retail spines in the City of Sydney and consist of active places that are the commercial and cultural focus for the local community.

Local Centre Areas are active and vibrant places at night, although the intensity of activity is distinctly lower than in Late Night Management and City Living Areas. Premises such as restaurants and licensed hotels will generally have shorter trading hours than their counterparts in other areas. This is due to the proximity of Local Centre Areas to residential and other sensitive land uses and thus greater potential to impact upon the liveability of local residents.

Such areas have good access to public transport at night, and offer a broad range of opportunities for passive and low-intensity recreation at night including restaurants, cafes, galleries, licensed hotels and retail uses.

Local Centre Areas may also include places within the City of Sydney that have the potential to support an increase in night time activity, particularly in instances where a notable number of commercial premises are vacant or underutilised such as south Regent Street in Chippendale or Botany Road in Green Square.

Local Centre areas should be safe places for people to go out at night and provide late night options for local communities; and can provide an alternative and respite from the sustained levels of activity that are characteristic of Late Night Management Areas. In some locations in Local Centres, low impact premises may have the potential to trade later than midnight, and up to 2am.

Although Local Centre Areas cater to people who live or work in the locality, they also have a minor role as destinations for people outside the CBD on weekends and therefore serve an important role in the hierarchy of night-time entertainment and recreational opportunities in the City.

Mix of uses and activities

In Local Centre Trading Areas, a mix of commercial and passive recreational uses is evident throughout the day and these uses flow on into early evening hours.

While traditionally at night the retail uses in Local Centre Areas have had a secondary role and cultural and recreational activities become the main focus, the demand for shops and businesses to stay open later to serve the needs of the local community has increased. Ideally, in Local Centres some retail uses will continue to operate during late night hours and have a complementary relationship with late night uses. These may include shops such as chemists, clothing stores, bookshops and supermarkets or businesses that supply local services, like drycleaners, hairdressers and medical centres. It is desirable that the urban village character of Local Centre Areas is sustained at night in order to maintain diversity. Premises within Local Centre Areas that operate exclusively at night are not encouraged.

Trading hours

Careful consideration will be given to the residential context of the area and existing hours of other late night trading premises in close proximity when assessing applications in these areas. Trading hours up to the maximum extended hours of operation permissible for local centre areas are acceptable where it is considered that the use:

- (a) will have minimal impact on residential amenity;
- (b) is characteristic of other uses in close proximity; and
- (c) where it will not contribute to the clustering of Category A premises.

In some locations in Local Centres it may be appropriate for low impact venues, to trade until 2am such as small bars, in accordance with their small bar liquor license. This will only be allowed where entry and egress to the premises is onto a main street and not a residential laneway or area.

Local businesses may also be able to trade until 2am to provide greater diversity and meet the needs of local communities.

Some areas have the potential to be Local Centre Areas (for example: Redfern, Botany Road) which have the capacity to support an increase in night-time activity that would encourage greater main street activity at night, ultimately contributing to revitalisation.

Issues and management

In order to maintain their relatively low level night-time activity and to promote diversity, it is desirable that a wide range of low impact night-time trading premises operate in Local Centre Areas. Thus, the clustering of high intensity premises is discouraged which will prevent a monoculture of high impact licensed premises that may adversely change the night time character of the locality. Local Centre Areas should characteristically have a strong presence of lower impact premises (eg. cafes, restaurants) that are 'anchored' by higher impact premises such as hotels.

An issue for Local Centre Trading Areas is residential development within and near the area, so proposals will differ based on whether there is nearby or surrounding residential development to the proposed premises. Plans of management will assist in this regard, as aside from the basic content they may also nominate specific mechanisms to manage proximity to residential premises. The type of use proposed may also assist, given that high-impact uses are discouraged in Local Centre Trading Areas, low-impact proposals are expected and given their very nature will have a lesser impact.

3.2

Plan of management requirements

- (1) A Plan of Management should be in the form of a separate attachment with an application and should be accompanied by a signed declaration from the licensee/manager that they have read and understood the Plan of Management. At a minimum, a Plan of Management should contain the following information:
 - (a) Site and locality details
 - (i) A description of the primary use of the premises as well as any secondary/ancillary uses (eg. retail liquor sales, public entertainment, outside trading areas, gaming areas etc). This may be in the form of a floor and/or site plan that indicates the use of all areas within the building or site;
 - (ii) Identification of any 'active areas' adjacent to the boundaries of the site used in association with the use of premises (eg. Outdoor seating, footway dining, queuing areas, parking etc);
 - (iii) A floor plan that indicates the proximity of external doors, windows and other openings to residential and other sensitive land uses. The floor plan should also indicate the proposed layout of all areas of the premises, such as internal queuing areas, seating, dining, gaming, dance floors, entertainment, lounge, etc;
 - (iv) Details of the maximum capacity of the premises and the maximum number of patrons that will be standing and/or sitting at any one time;
 - (v) The location of waste storage areas;
 - (vi) Location of air conditioning, exhaust fan systems and security alarms;
 - (vii) Identification of the most commonly used pedestrian routes to and from the premises, including any safety corridors.
 - (b) Operational details
 - (i) An overview of the organisation in the form of a brief statement that provides details about the company/licensee/proprietor that includes information regarding:
 - the number and type of staff (including security);
 - other similar premises within the company's portfolio (if relevant);
 - any Liquor Licenses for the premises;
 - a description of any actions that the proprietor/licensee has taken to co-operate with NSW Police, the local community and incorporated resident groups regarding the management of the premises;
 - membership of a Licensing Accord within the City of Sydney (please refer to the City's website for details of Licensing Accord operating within the City).
 - (c) Hours of Operation
 - (i) For existing premises seeking a renewal or extension of trading hours, a schedule of the current trading hours showing the range for each day. For example; this should be expressed in the following format:

- 9am Friday to 2am Saturday
 - 9am Saturday to 2am Sunday
 - 9am Sunday to 1am Monday
 - 9am Monday to midnight Monday
 - 9am Tuesday to 11pm Tuesday
 - 9am Wednesday to 2am Thursday
- (ii) A schedule of the proposed operating hours for each day of the week for all areas of the premises (eg. courtyards, rooftop, balcony, footway, gaming room etc.) showing the range of hours proposed for each day in the format above. If the nature of an area changes, for example, a dining area becomes a dance floor after the kitchen closes, then this should be noted and operational hours for the different uses detailed and
- (iii) If applicable, a schedule of proposed entertainment hours for each day of the week in the format above.
- (d) Noise
- (i) The identification of all likely noise and vibration sources associated with the operation of the premises. This may include such sources as:
- Live entertainment and amplified sound;
 - external (outside) areas such as courtyards, rooftops, balconies etc;
 - patrons leaving and entering the premises;
 - the operation of mechanical plant and equipment;
 - waste disposal, sorting and collection of bottles etc
 - in stand-alone gyms in buildings with residential accommodation, background music, air conditioning and the use of exercise machines and free weights.
- (ii) Details of all noise and vibration attenuation measures related to the use and operation of the premises.
- (iii) A statement outlining the premises' compliance with all relevant noise and vibration standards, guidelines and legislation (eg. Australian Standards, Protection of the Environment Operations Act 1997, EPA Industrial Noise Guidelines, etc.);
- (iv) Details of how management will address complaints relating to noise, and any noise control strategies that will be implemented to minimise the potential for complaints (eg. liaison with neighbours and local police, maintaining a complaint register etc);
- (v) Details of any measures that will be taken to minimise noise from outdoor areas such as rooftops, courtyards, balconies or designated smoking areas etc; and
- (vi) Details of any noise limiting devices to be installed;
- (di) Security and safety – may only be applicable for licensed premises or takeaway food and drink premises located close to late night licensed premises.

- (i) A description of any arrangements that will be made for the provision of security staff. This is to include (but is not limited to) the following:
 - any recommendations from Local Licensing Police regarding appropriate security provision and a statement outlining the extent of compliance with police recommendations;
 - the number of security personnel that will be patrolling inside and outside the premises including the frequency of security patrols;
 - Identification of the physical extent of any patrolled areas outside the premises;
 - Hours that security personnel will be on duty (including the period after closing time);
 - Staff security training, weapons detection, and other security response methods.
 - (ii) Details of CCTV surveillance camera installation that identifies both indoor and outdoor areas monitored by cameras, and camera technical specifications (eg. recording capacity, frames per second etc.)
 - (iii) Details of signage that is to be erected providing advice to patrons to maintain quiet and order when leaving and entering the premises;
 - (iv) Details of any liaisons or outcomes of any meeting with local NSW police; and
 - (iv) Details of any complaints associated with the operation of the premises must be recorded in a Complaints Register which includes:
 - Complaint date and time;
 - Name, contact and address details of person(s) making the complaint;
 - Nature of complaint;
 - Name of staff on duty;
 - Action taken by premises to resolve the complaint;
 - Follow-up; and
 - Outcome.
- (f) Management Measures
- General Amenity:
- (i) Details of all measures that will be taken to ensure that amenity impacts that may result from the operation of the premises are minimised.
 - (ii) Details of all actions that will be taken to respond to complaints made about the operation of the premises (including but not limited to consultations with residents, discussions with Council Officers, liaison with Police, public access to Plans of Management, review of existing Plan of Management etc.);
 - (iii) A waste management plan that outlines the procedures for minimising and managing waste that is generated by the premises. This should address such matters as disposal of bottles, how and when waste will be removed, details of waste management facilities, waste collection and storage areas etc;

- (iv) Details of methods that will increase patron awareness of public transport availability (eg. signage, availability of timetables) as well as a description of any other measures that will assist patrons in using public transport (eg. provision of a shuttle service, taxi assistance etc.); and
- (v) Details of methods that will increase patron awareness of responsible disposal of cigarette butts;
- (vi) Any other measures that will be undertaken to ensure that amenity impacts that may arise from the operation of the premises are addressed.

Security and Safety (where applicable):

- (i) Measures that will be taken by security personnel to ensure that the behaviour of staff and patrons when entering or leaving the premises will minimise disturbance to the neighbourhood.
- (ii) Any provisions that will be made to increase security in times where higher than average patronage is expected (eg. during public entertainment, peak periods on weekends, New Years Eve, following large sporting events in the locality, during special events and functions etc.);
- (iii) Liaison that will be undertaken with other licensees or operators of late trading premises in the locality/area to improve security at night;
- (iv) Detail procedures and provisions that will be implemented to improve premises security. This could include:
 - emergency procedures;
 - crowd control;
 - search procedures;
 - maintenance of an incident register;
 - monitoring of patron behaviour;
 - monitoring of numbers of patrons within the premises;
 - recording of complaints and reporting of incidents to Police;
 - membership of the proprietor/licensee to a Licensing Accord (see the City's website for details of Licensing Accords operating within the City);
 - dress codes;
 - staff security training;
 - distinctive security attire;
 - availability of cloak rooms;
 - internal and external security patrols;
 - measures to prevent glass being carried from the premises by patrons;
 - measures to ensure safe capacities (eg. electronic counting of patrons, occupancy limits, signage); and
 - actions to be taken during 'wind down' periods prior to closing time.

- (v) If queuing outside the premises is to occur, a description of any measures that will be taken to ensure that queuing is controlled in a manner that will not adversely impact the amenity of the neighbourhood and that the footpath will not be unreasonably impeded. This description may address such matters as:
- A description of how and how often security guards will monitor queues (e.g. security guards will monitor queues every 10 minutes to identify inappropriate behaviour before patrons enter); the use of temporary ropes and bollards;
 - maximum queue numbers;
 - actions taken to minimise loitering; and
 - actions ensuring the fast and efficient movement of a queue.

Optional issues that may be required in relation to an application for a liquor license

- (vi) Methods employed to implement harm minimisation and the responsible service of alcohol (RSA) requirements such as:
- employee training and awareness regarding RSA and harm minimisation;
 - approaches that will be used to manage intoxicated and/or disorderly persons;
 - promotion of non-alcoholic beverages and provision of free water;
 - display of the premises' house policy;
 - assisting patrons in accessing safe transportation from the premises (eg. arranging taxis, public transport timetable information);
 - encouraging responsible drinking;
 - number of RSA marshalls employed for each shift and details on how they will monitor RSA; and
 - actions taken to discourage drug use and to manage drug related incidents.
- (vii) Detail emergency and evacuation procedures in accordance with the relevant Australian Standard and provide details of staff training in those procedures.
- (g) Performance, creative or cultural uses (where applicable)
- (i) A description of the music, visual, performance, creative and cultural events that may be staged at the premises;
 - (ii) Details of the capacity of the space to host performance, creative or cultural uses including the location and dimensions the space, stage audience (standing or seating area) and equipment to present the performance, creative or cultural use;
 - (iii) Arrangements for booking and promoting performance, creative and cultural uses;
 - (iv) Procedures for notifying neighbours about the nights when operating hours are extended to provide for performance, creative and cultural uses.

Schedule 4

Projections over or into public roads

Note: Awnings are separately addressed in Section 3

Objective

- (a) Projections beyond private property boundaries over or into the public road/footpath are to contribute to the amenity and character of the street, not cause obstruction or a loss of safety for users of the street, and meet the relevant requirements of the *Roads Act 1993*.

Provisions

- (1) Projections for decoration or sun shading devices
 - (a) Building elements designed for decoration or as sun shading devices may project beyond the road/footpath alignment if the projection: extends not more than 450mm over the road/footpath alignment; is at least 3m above the footpath; is at least 800mm from the face of the kerb; and is constructed primarily of masonry, reinforced concrete, steel or other approved non combustible material.
- (2) Balconies and bay windows
 - (a) Balconies and bay windows may project beyond the alignment of a road/footpath if the projection extends not more than 450mm over the road/footpath alignment, comprises not more than 50% of any road frontage of the building at any level, is at least 3.2m above the footpath and at least 800mm from the face of the kerb, and does not result in adverse impacts on the amenity of an adjoining property.
- (3) Flagpoles, pipes and services, sewerage pipe traps, and footings
 - (a) Flagpoles may project over the road/footpath alignment if the poles and flags/banners suspended from the poles are at least 3.2m above the footpath, and at least 800mm from the face of the kerb, and do not interfere with public services.
 - (b) Pipes and services for existing buildings may project over the road/footpath alignment provided they are essential and cannot be located within the building. In particular, rainwater heads are not to project more than 450mm over the road/footpath and rainwater downpipes are not to project more than 150mm, and all projections are to be at least 2.7m above the road/footpath.
 - (c) For existing buildings, traps on sewerage service pipes and reflux valves may be installed in the road. For new buildings, traps on sewerage service pipes and reflux valves are not to be installed in the road.
 - (d) Footings may project beyond the alignment only under the footpath, not under the carriageway, and not more than 450mm if the projection is at least 1.35m below footpath level, and 750mm if the projection is at least 3m below footpath level.

Schedule 5

Public open space dedication and design criteria

The following table sets out criteria that apply to any land that is to be dedicated to Council for the purpose of public open space.

Size	<p>Local parks are to be a minimum of 3,000-5,000sqm unless the proposal will increase an area of adjoining open space or provide a lineal connection to nearby open space. Spaces need to be large enough to create a sense of openness and provide usable green spaces.</p> <p>5,000sqm is preferred as it allows for the accommodation of a variety and diversity of open space uses and amenity.</p>
Shape	<p>Regular shapes, square or rectangular, are preferred to allow flexibility for useable open space.</p> <p>The minimum width for access corridors (linear parks) is 10m.</p> <p>Long narrow parks are generally unacceptable unless the prime function is for linking larger park areas.</p>
Comfort and amenity	<p>Good solar access, protection from wind and traffic noise and a visually attractive environment for users is to be provided.</p>
Accessibility	<p>The location and park landscape should maximise access for people with mobility difficulties.</p>
Distance from any residence	<p>All residents should be within a ten minute walk (approximately 400m) of local open space.</p>
Park boundary	<p>It should be clearly demonstrated that the park is public open space.</p> <p>A park is to have at least 50% frontage to a street and at least three sides of the park are to be street/lane frontages.</p> <p>Corner street frontages are preferred to ensure identification as a public place and to contribute to security and surveillance of the site.</p> <p>A substantial length of road frontage is crucial for local parks to ensure access, good community surveillance and legibility of the public domain.</p>
Connectivity	<p>The park should be located on identified pedestrian and cycle routes and provide opportunities to link to adjoining open space.</p> <p>Safe and convenient access is to be provided.</p> <p>The location and urban design is to provide for multi-mode access.</p>
Land Quality	<p>Maximum slope in the park is to be 1:4.</p> <p>The park is to be fit for purpose (generally flat and usable) and not constrained by contaminated land restrictions or property easements.</p> <p>Assessing the land quality will minimise development and maintenance costs and ensure long term flexibility for the use of the park.</p>

Schedule 6

Signage in The Rocks

This schedule provides information to assist tenants, consultants and fabricators on high quality signage appropriate for The Rocks precinct.

Below are different signage applications applicable in The Rocks precinct. Over page, further detail is provided on each application type.

Following the application type details is a map illustrating the location of each application area and matrix showing which signs are allowable in each area.

- **A: Facades to narrow streets, lanes and passages**
Applies to commercial/retail frontages without awnings, up to 4 storeys high, along the narrower streets in the precinct. Refer to 7.1
- **B: Facades to wide streets**
Applies to commercial/retail frontages without awnings, up to 6 storeys high, along the wider streets in the precinct and includes warehouses, commercial office buildings. Refer to 7.2
- **C: Terraces with party walls**
Applies to terrace rows characterised by party walls and set back from walls. Refer to 7.3
- **D: Terraces with cantilevered balconies**
Applies to two storey terrace rows characterised by cantilevered timber balconies at first floor level e.g. Playfair Terraces. Refer to 7.4
- **E: Shopfronts generally**
Applies to shopfronts with display windows. Refer to 7.5
- **F: Awnings and fascias**
Applies to frontages with awnings and verandahs. Refer to 7.6
- **G: Restaurant menus**
Applies to menus displayed outside restaurants/cafes etc. Refer to 7.7
- **H: Temporary signs and temporary promotional shopfront window sign**
Applies to all commercial businesses including real estate signage. Refer to 7.8
- **I: Construction site hoardings**
Applies to temporary hoardings around construction or archaeological sites. Refer to 7.9
- **J: Tall building signage**
Applies to the area of The Rocks that is south of the Cahill Expressway and contains a number of buildings over 6 storeys in height. Refer to 7.10
- **K: Major multiple tenancy building signage**
Applies to Argyle Centre, Metcalfe Arcade and Campbell's Stores

6.1

A – Facades to narrow streets, lanes and passages

Application	This applies to commercial building frontages generally and including former warehouses, coach houses and shops (historic and contemporary) and other buildings up to 4 storeys high without awnings located along the narrower streets in the precinct.
Objective	<ul style="list-style-type: none"> To regulate signage for retail and commercial premises To preserve spatial character of streets To preserve the characteristic Rocks skyline as seen from external vantage points and to distinguish it from the Sydney skyline generally To provide reasonable exposure for building/tenant identification To promote good contemporary design in The Rocks, sympathetic to its heritage qualities
Permissible sign types	<p>SS1 – shingle signs – 450x1000*</p> <p>SS2 – shingle signs – 675x675* (min. 4m centres)</p> <p>WP1 – wall plaque – 280x400* (or alternatively WP4 menu plaque)</p> <p>* dimensions in mm (w x h) are maximum permissible size</p>
No. of signs	Maximum one shingle and one wall plaque per tenancy.
Illumination	Indirect. Back-lit cut-out plaques will be considered in some areas.
Specifications	For plaque details and fixings into masonry and stone, refer to specification note 1. For details and fixing of shingle signs, refer to specification note 2.
Notes	<p>All graphics to be professionally designed and approved as part of the development application.</p> <p>Wall plaque signs may be converted to menu type signs to provide flexibility for variable messages, promotional sales and the like.</p>

6.1.1 A – Technical Drawing

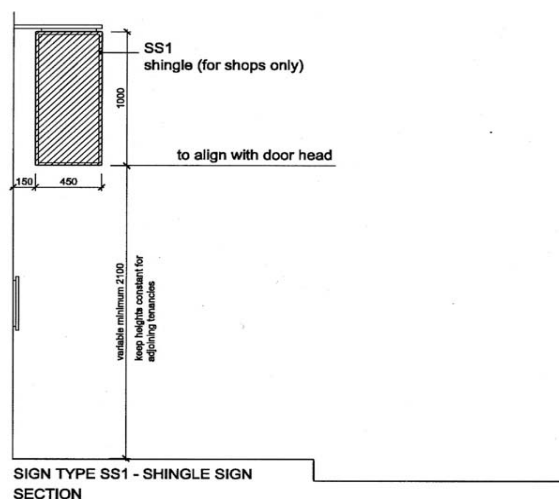

SIGNAGE IN THE ROCKS

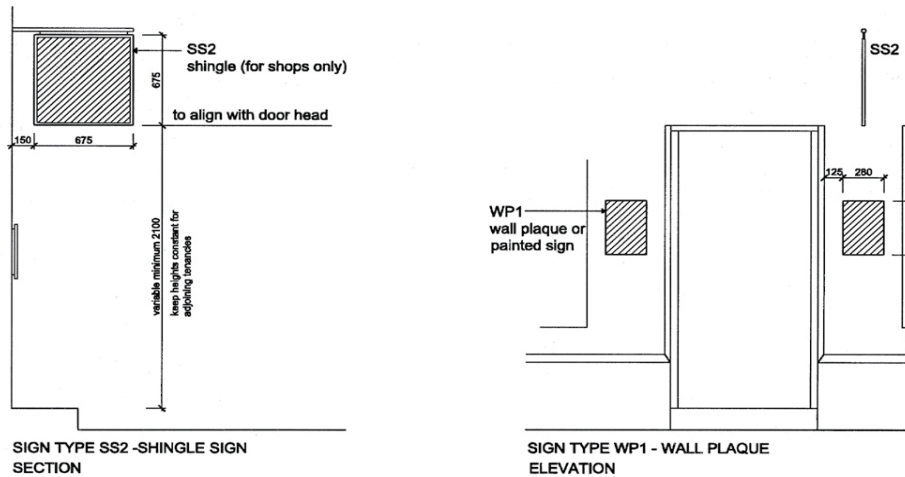

6.2

B – Facades to wide streets

Application	This applies to commercial retail building frontages without awnings, up to 6 storeys high, located along the wider streets and avenues of the precinct. This includes former warehouses and commercial office buildings.
Objective	<ul style="list-style-type: none"> To regulate signage outside retail and commercial premises To preserve spatial character of streets To preserve the characteristic Rocks skyline as seen from external vantage points and to distinguish it from the Sydney skyline generally To provide exposure for building/tenant identification To promote good contemporary design in The Rocks, sympathetic to its heritage qualities
Permissible sign types	<p>SS3 – shingle signs*** – 650x1200* (min. 6m centres)</p> <p>WP1 – single tenancy wall plaque - 280x400*</p> <p>WP2 – multiple tenancy wall plaque** - 500x1200* ** (or alternatively WP4 menu plaque)</p> <p>* dimensions in mm (w x h) are recommended maximum size</p> <p>** multiple tenancies can be listed on separate panels mounted onto the same plaque</p> <p>*** SS3 applies to tenancies with direct street access only</p>
No. of signs	Maximum one shingle and one wall plaque per tenancy.
Illumination	Preferably no lighting, but indirect lighting from behind plaques may be considered.
Specifications	For plaque details and fixings into masonry and stone, refer to specification note 1. For details and fixing of shingle signs, refer to specification note 2.
Notes	<p>All graphics to be professionally designed and approved as part of the development application.</p> <p>Wall plaque signs may be converted to menu type signs to provide flexibility for variable messages, promotional sales and the like.</p>

6.2.1 B – Technical Drawing

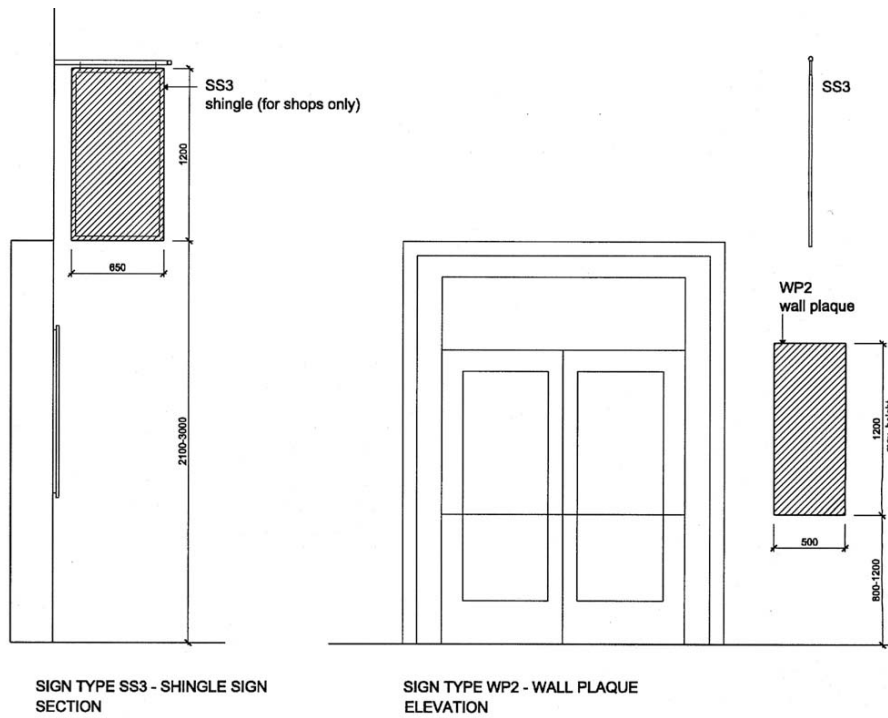

6.3

C – Terraces with party walls

Application	Limited application where terraces are characterised by verandah set back with expressed party walls e.g. Sergeant Major’s Row.
Objective	<ul style="list-style-type: none"> To enhance the characteristic rhythm of terrace house party walls To maintain the integrity of the original structures To provide reasonable exposure for building/tenant identification To promote good contemporary design in The Rocks, sympathetic to its heritage qualities
Permissible sign types	<p>WP1 – front wall plaque – max. 200x400* (fixed as shown in Specification Note 1 (one only per tenancy), or alternatively WP4 menu plaque)</p> <p>PS1 – painted sign on party wall - to be limited to one side of party wall</p> <p>PS2 – Painted sign on plaque - signage on one side only, to be consistent with entire terrace row, plaque to be fixed into niche or on surface of party wall at both ground and first floor levels (only one per building)</p> <p>RP1 – Removable placard – max. 425x600* (fixed to palisade fence, this option is for temporary installations such as exhibition posters or restaurant menus)</p> <p><i>* dimensions in mm (w x h) are recommended maximum size</i></p>

SIGNAGE IN THE ROCKS

No. of signs	Maximum one shingle and one wall plaque per tenancy.
Illumination	Preferably no lighting, but indirect lighting from balcony soffit or from behind plaque may be considered.
Specifications	For plaque details and fixings into masonry and stone, refer to specification note 1. For details and fixing of shingle signs, refer to specification note 2.
Notes	Wall plaques may be converted to menu type signs to provide flexibility for variable messages, promotional sales and the like.

6.3.1 C – Technical Drawing

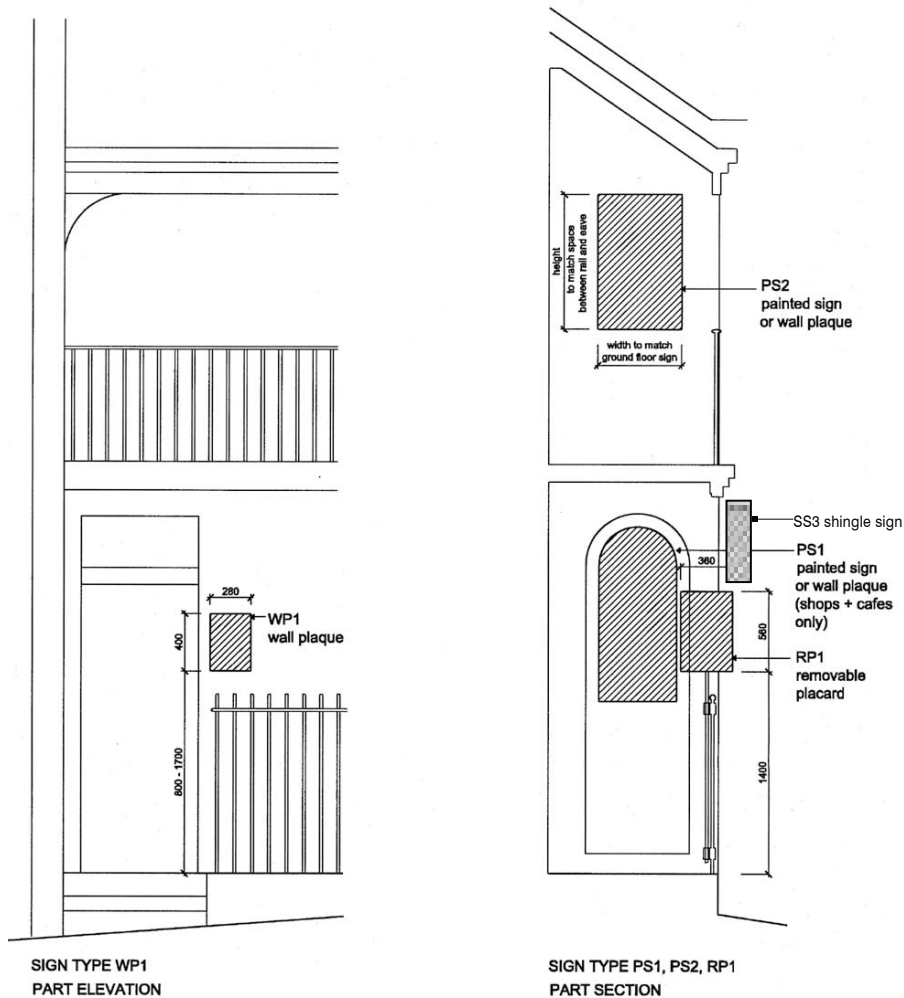

6.4

D – Terraces with cantilevered balconies

Application	The applies to simple two storey residential terraces with cantilevered timber balconies at first floor level e.g. Playfair Terraces.
Objective	<ul style="list-style-type: none"> To replace suspended signage fixed to edge of balcony To restore the characteristic prominence of the cantilevered balconies To provide reasonable exposure for building/tenant identification To promote good contemporary design in The Rocks, sympathetic to its heritage qualities
Permissible sign types	<p>WP1 – front wall plaque – max. 280x400* (fixed as shown, one per tenancy)</p> <p>PS3 – wall plaque (fixed to surface of first floor balcony dividing wall or alternatively painted sign)</p> <p>SS4 – shingle sign (fixed to soffit of cantilevered balcony)</p> <p>* dimensions in mm (w x h) are recommended maximum size.</p>
No. of signs	One only per tenancy
Illumination	Preferably no lighting, but indirect lighting from balcony soffit or from behind plaque may be considered
Specifications	For plaque details and fixings into masonry and stone, refer to specification note 1. For details and fixing of shingle signs, refer to specification note 2.
Notes	All graphics to be professionally designed and approved as part of the development application.

6.4.1 D – Technical Drawing

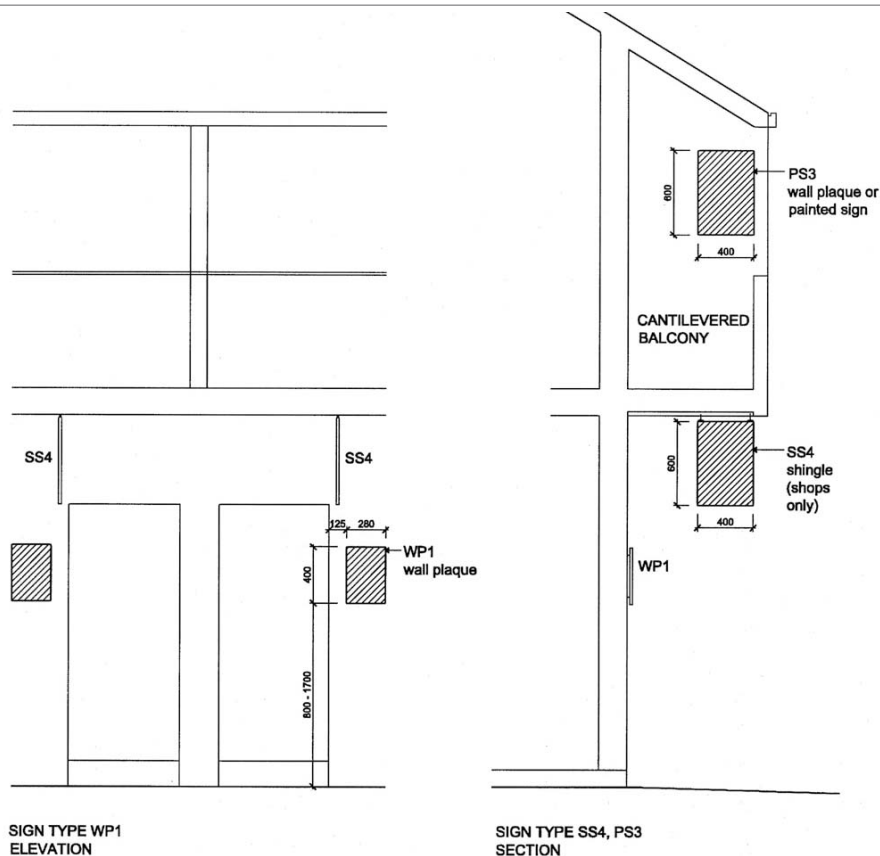

6.5

E – Shopfronts

Application	Retail frontages with glass display windows
Objective	<ul style="list-style-type: none"> To maintain integrity of shopfronts To provide reasonable exposure for building/tenant identification To promote good contemporary design in The Rocks, sympathetic to its heritage qualities
Permissible sign types	<p>TS1 – painted transom panel above shop entry door (text should not exceed 80% of the available height and should be limited to business name or street number)</p> <p>SW1 – shingle sign on shop window (field area of the sign can occupy up to 10% of glazed surface area)</p> <p>HS1 – hamper signage – field area of the sign can occupy up to 80% of the hamper's glazed surface area)</p> <p><i>* dimensions in mm (w x h) are recommended maximum sizes</i></p> <p>Notes: Signage inside shop window should be at least 900mm inside glazing. Internally illuminated signage or flashing or moving signage is not allowed inside shopfronts. For restaurant menus inside shop windows see Guideline G.</p>
No. of signs	One of each sign type per shopfront
Illumination	Limited to ambient street and under awning lighting and from inside the shop window
Specifications	n/a
Notes	All graphics to be professionally designed and approved as part of the development application.

6.5.1 E – Technical Drawing

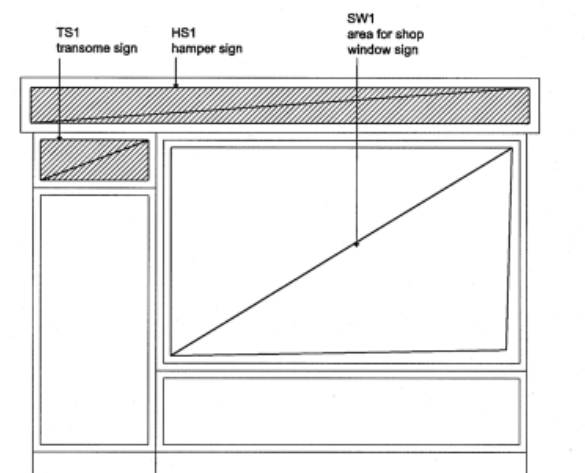

SIGN TYPE TS1, HS1, SW1
STREET ELEVATION

6.6

F – Awnings and fascias

Application	Awnings, verandahs and colonnades projecting from the main building face. Refer to 7.5 for manual relating to shop front windows, hampers and transoms.
Objective	<ul style="list-style-type: none"> To preserve character of projecting awnings To modulate street edges where defined by awning fascias To provide reasonable exposure for building/tenant identification To promote good contemporary design in The Rocks, sympathetic to its heritage qualities
Permissible sign types	<p>SU1 – Suspended signs – 2000x350* max. (limited to one for each tenancy or spaced at a maximum of 6m centres for longer frontages)</p> <p>PF2 – front fascia sign (painted text to be max 80% of available height)</p> <p>PF1 – side fascia sign (to match graphics on street front fascia and positioned to suit the shape of the fascia)</p> <p><i>* dimensions in mm (w x h) are recommended maximum sizes</i></p>
No. of signs	One suspended sign and front fascia sign per shopfront. One side fascia sign per external exposed side fascia
Illumination	Indirect from soffit of awning for suspended signs only.
Specifications	n/a
Notes	All graphics to be professionally designed and approved as part of the development application.

6.6.1 F – Technical Drawing

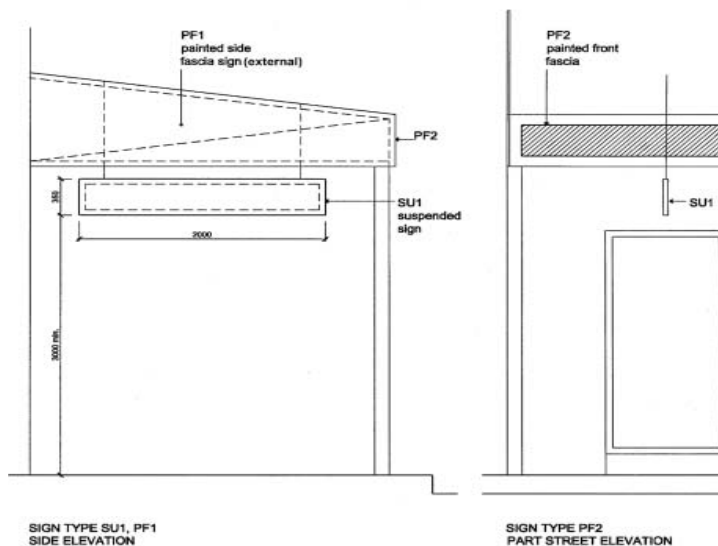

6.7

G – Restaurant menus

Application	Menus displayed outside restaurants and cafes. The design should be considered in conjunction with the commercial fit out of the restaurant or café.
Objective	<ul style="list-style-type: none"> To regulate signage outside retail and commercial premises To preserve spatial character of streets To provide reasonable exposure for building/tenant identification To promote good contemporary design in The Rocks, sympathetic to its heritage qualities
Permissible sign types	<p>RP1 – Removable placard signs (to be used together with palisade fencing)</p> <p>WP4 – Wall mounted menu boxes – 360x560*</p> <p>WP3 – Menu box (set into existing naming plaque recess)</p> <p>SW2 – Menu box (mounted inside shopfront, overall dimensions 350x560* max.)</p> <p>* dimensions in mm (w x h) are recommended maximum size</p>
No. of signs	Maximum one menu per tenancy.
Illumination	Discrete spotlights or gentle lightbox effects considered subject to impact on fabric and presentation.
Specifications	For plaque details and fixings into masonry and stone, refer to specification note 1. For placard details, refer to specification note 3.
Notes	<p>All graphics to be professionally designed and approved as part of the development application.</p> <p>Free-standing removable menu boards at the edges of commercial outdoor seating areas are not allowable.</p>

6.7.1 G – Technical Drawing

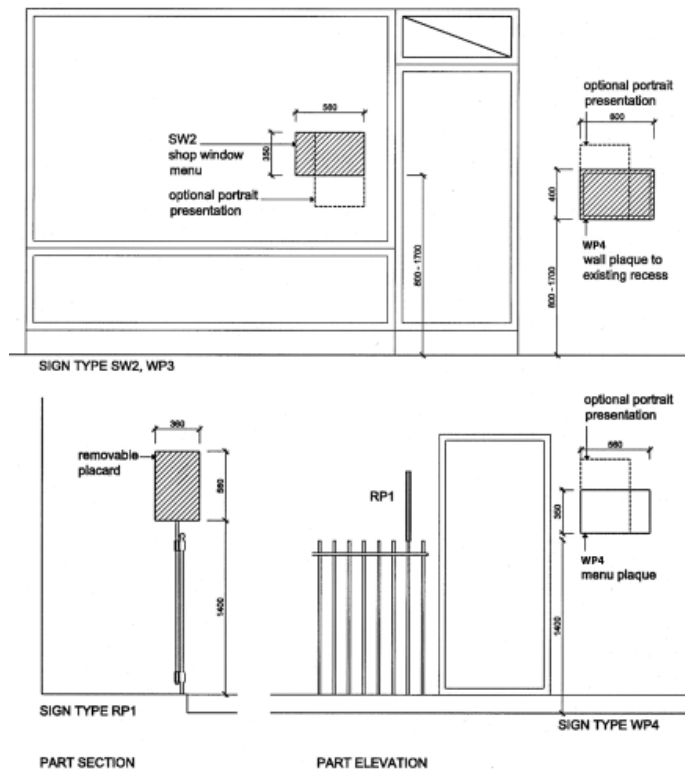

6.8

H – Removable/temporary signage

Application	This guidelines applies to all commercial businesses including real estate signage.
Objective	<ul style="list-style-type: none"> To preserve visual and spatial simplicity of streets and lanes To protect building fabric from permanent and disfiguring fixings To allow for temporary promotion of events, gallery exhibitions and leasing opportunities To allow for a flexible system of temporary signage To promote food contemporary design in The Rocks, sympathetic to its heritage qualities
Permissible sign types	<p>RP1 – Placard signs (to be used with existing palisade fencing only i.e. for terrace houses described in 7.3. Placards must be removed at the end of each trading day.)</p> <p>PW1 – Promotional signage (displayed for a maximum of 30 business days and maximum 2 events per year. Window sign can be maximum 25% of window area)</p> <p>RE1 – External real estate signs (up to 3m² may be installed on all buildings north of the Cahill Expressway and all heritage buildings south of Cahill Expressway for up to 4 months** if:</p> <ul style="list-style-type: none"> No building fabric of exceptional or high significance is obscured There are no fixings into fabric of exceptional or high significance Signs are mounted flush to the face of the building <p>Final sizes and dimensions are to be assessed on a case by case basis.</p> <p>RE2 – Real estate signs (may be installed for up to 4 months**. Signs can take up to 100% of the glazed area in a single window bay but graphic design and exact dimensions will be subject to approval. Window signs should not be fixed to glass or frames, mullions, transoms etc.)</p> <p><i>* dimensions in mm (w x h) are recommended maximum sizes</i></p> <p><i>** multiple tenancies can be listed on separate panels mounted onto the main plaque</i></p>
Exempt and complying signage	<p>RE1 – External real estate signs (up to 2.5m² for residential buildings and 4.5m² for commercial buildings may be installed on all non heritage buildings south of the Cahill Expressway for up to 4 months</p> <p><i>* dimensions in mm (w x h) are recommended maximum sizes</i></p>
No. of signs	<p>RP1 and PW1 – One sign of either type per art gallery or exhibition space only.</p> <p>RE1 – One real estate sign for each frontage, with a maximum of 2 signs for an entire building at any one time.</p> <p>RE2 – One real estate sign for each frontage for each vacant tenancy</p>
Illumination	No illumination
Specifications	For placard details, refer to specification note 3.
Notes	<ul style="list-style-type: none"> All graphics to be professionally designed and approved as part of the development application Graphic design for real estate signs in windows should incorporate interpretive material relating to the history of the building and/or the immediate precinct Temporary signs, other than real estate and leasing signage, must be removed at the close of business each day and may only be used to promote sales within fixed duration of up to 30 business days <p>** For RE1 and RE2, if the property is leased before the specified time limits then signs should be removed within 10 days of the conclusion of the lease transaction</p>

6.8.1 H – Technical Drawing

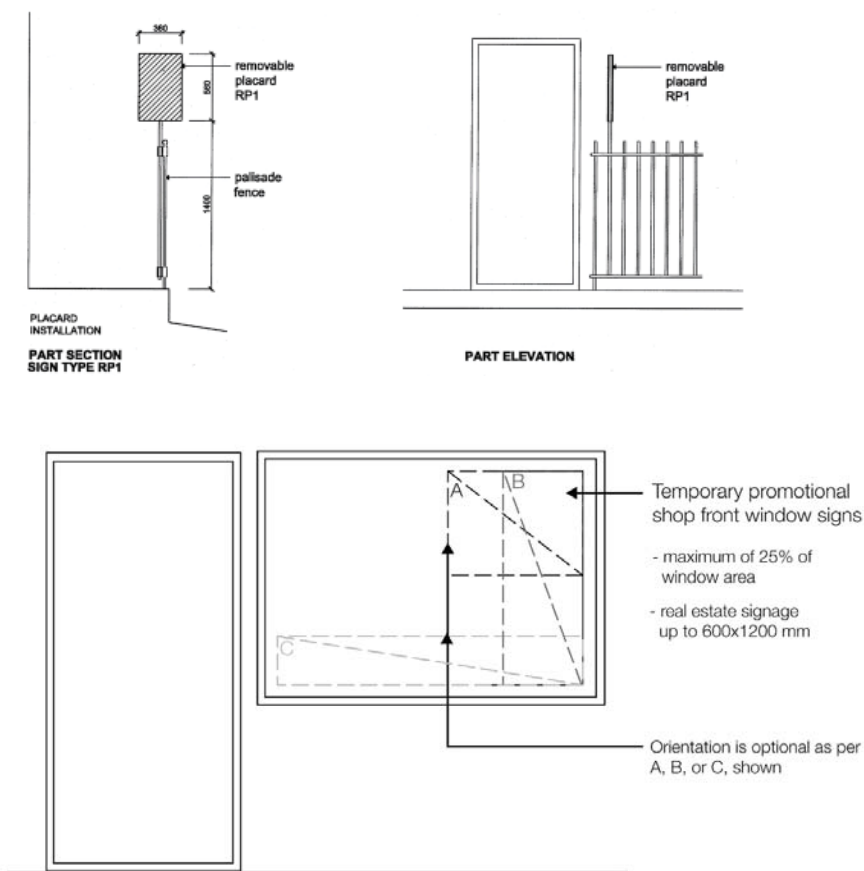

6.9

I – Construction site hoardings

Application	The applies to temporary hoardings around archaeological sites and construction sites.
Objective	<ul style="list-style-type: none"> To preserve spatial character of streets To promote good contemporary design in The Rocks, sympathetic to its heritage qualities
Permissible sign types	<p>TH – painted hoardings</p> <p>TF – Fabric mesh on chainwire fence</p> <p>TP – Panels fixed to chainwire fencing or scaffolding</p> <p><i>* dimensions in mm (w x h) are recommended maximum sizes</i></p>
No. of signs	Extent of hoarding to be subject of agreement
Illumination	No illumination
Content	<ul style="list-style-type: none"> Size of graphics will be restricted, especially where hoarding is visible from Sydney Harbour or major road ways Background colour should be plain to match Pantone Warm Grey 1C. Alternatively, a custom designed pattern me be acceptable

Content (continued)

Graphics should be limited to:

- Accreditation for construction/development team (minimal contact details) and formatted onto a single panel. This information can be repeated once on each sheet frontage only. Overall dimensions of this sign should take into account the length of the frontage, street width, site visibility etc
- Interpretive information on history/significance of the site etc, together with viewing panels as appropriate
- Specially designed graphics incorporating the nature of the project and the visual character of the context

6.10

J – Tall buildings

Application	<p>This applies to the area of The Rocks that is south of the Cahill Expressway and bordered by Cumberland Street, Grosvenor Street and George Street. This area contains a number of buildings over 6 storeys in height that are of a different character to smaller scale buildings elsewhere in The Rocks precinct. Tall building signage has the potential to impact the surrounding environment in a variety of ways and therefore requires a specific set of guidelines. These guidelines are intended to protect the significant characteristics of buildings, streetscapes, vistas and the city skyline and to encourage well-designed and well-positioned signs.</p> <p>Street level signage will be assessed on a case by case basis. In addition, guidelines in 7.2 may be applied in design and assessment of street level signage in this area.</p>
Objective	<ul style="list-style-type: none"> • To promote signs that add character to the streetscape and assist with wayfinding and the pedestrian usability of the city • To promote signs that complement the architectural style and use of buildings • To encourage suitably located signs that provide a legible and clear message through the use of high quality materials and a high standard of graphic design • To consider the amenity of surrounding residential and heritage development and the visual quality of the public domain
Guidelines	<p>Signs are to be designed to:</p> <ul style="list-style-type: none"> • Be integrated with the architectural design of the supporting building and to ensure that significant architectural features are not obscured • Have regard to the view of the sign and any supporting structure, cabling and conduit from all angles including visibility from street level, nearby higher buildings and against the skyline • Have only minimal projection from a building • Not contain additional advertising promoting products or services other than the approved use of the premises or site (such as logos or brands of products) irrespective of whether that product or service is sold on the site • Not be supported by or hung from other signs <p>Further guidelines are as follows:</p> <ul style="list-style-type: none"> • Corporate identification such as corporate logos, colours and other graphic elements is permitted but modification may be required such as a reduction in colour intensity, inverting graphic components, deleting backing elements or by the innovative use of materials • Signs should not exceed two words • Signs painted on or applied to the roof are prohibited • Signs should generally be below the parapet • Tower signs will be limited to one per building • The visual impact from the harbour will be a key consideration, as will the impact on the night time skyline of the city. The use of exposed neon will not be permitted

SIGNAGE IN THE ROCKS

Guidelines (continued)	<ul style="list-style-type: none"> Signage should be no greater than 50% of the width of the viable frontage of the building. Signs painted on or applied to the roof are prohibited <p><i>* dimensions in mm (w x h) are recommended maximum sizes</i></p>
Illumination	<ul style="list-style-type: none"> Illuminated signs are not to detract from the architectural character of the supporting building during daylight Illumination (including cabling) is to be: <ul style="list-style-type: none"> Concealed Integral with the sign Provided by means of carefully designed and located remote or spot lighting The ability to adjust the light intensity of illuminated signs is to be installed where deemed necessary by the consent authority A curfew may be imposed on the operation of illuminated signs where continuous illumination may impact adversely on the amenity of surrounding heritage development, residential buildings, services apartments or other visitor accommodation, or have other adverse environmental effects. Uplighting of signs is prohibited. Any external lighting of signs is to be downward pointing and focused directly on the sign.
Notes	All graphics to be professionally designed and approved as part of the development application.

6.11

K – Major multiple tenancy buildings

Application	The applies to The Rocks Centre, Argyle Stores, Metcalfe Arcade and Campbell's Stores, being buildings with multiple tenancies, where the tenants have no direct frontage to a commercial street.
Objective	<ul style="list-style-type: none"> To identify the 4 nominated buildings by name To clearly indicate the predominant tenancy types housed within the building i.e. 'shopping' or 'dining' and make this apparent from the street To be sympathetic to the heritage character of the nominated buildings and the surrounding precinct To develop a consistent sign type for the 4 buildings
Design principles	<p>A lightweight banner may be installed to identify each of the 4 nominated buildings provided that:</p> <ul style="list-style-type: none"> No fabric of exceptional or high significance is obscured Banners do not obstruct significant vistas Banners are limited to key approaches The banner may be mounted directly to the building provided that the fixing design is determined on the basis of a detailed heritage investigation for each building The design for each building will be unique, however, as a principle the banner may be up to 600x3000 with strong vertical proportions The banner will contain the name of the building and the predominant building function e.g. 'shopping' or 'fine dining' A colour scheme for the family of signage banners for each building is to be professionally developed
Notes	<p>The signage banners may only contain wording as outlined in the Design Principles. Individual tenant names, corporate logos or advertising are not permitted</p> <p>A maximum of 2 banners may be permitted for each of the nominated buildings – to be determined on a case by case basis – in context of other existing signs on the building and visibility of the building from key approaches.</p>

6.11.1 K – Technical Drawing

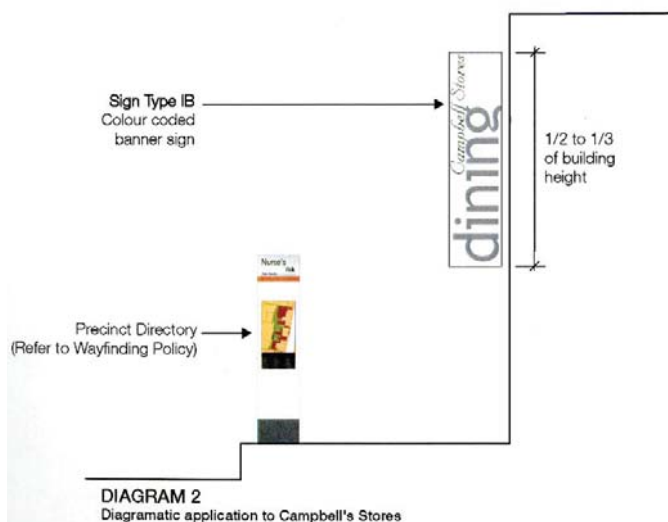
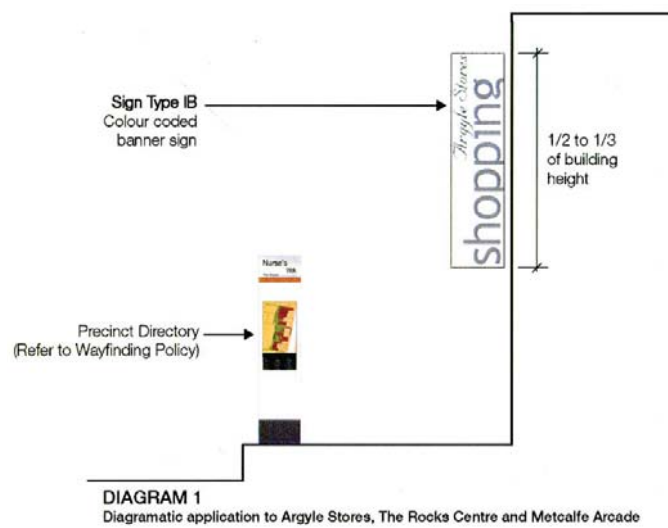

6.12

Specification Note 1

6.12.1 General Fixing Notes

- Use existing holes where possible
- Minimise number of new penetrations to existing fabric
- Use spacers to hold signs 10-30mm proud of wall surface
- Do not cover building forms, moulds or patterns
- Do not apply any finishes to signs in situ
- Ensure all metals used on signs are corrosion proof so that rust stains will not be caused on wall surfaces
- Fixings into wall are to be stainless steel or bronze

6.12.2 Masonry Fixing Notes

- Use screw fixings with rawplugs, timber or plastic
- Where masonry is in a saline environment, use metal fasteners equal to :Monel: screws which will not corrode
- Do not use expanding masonry anchors or chemically bonded anchors
- Where ever possible utilise mortar joints as points of fixing
- Use lime mortar to repoint stonework if required, not cement render
- Do not use elastometric to repoint joints
- Fixings into wall are to be stainless steel or bronze

6.13

Specification Note 2

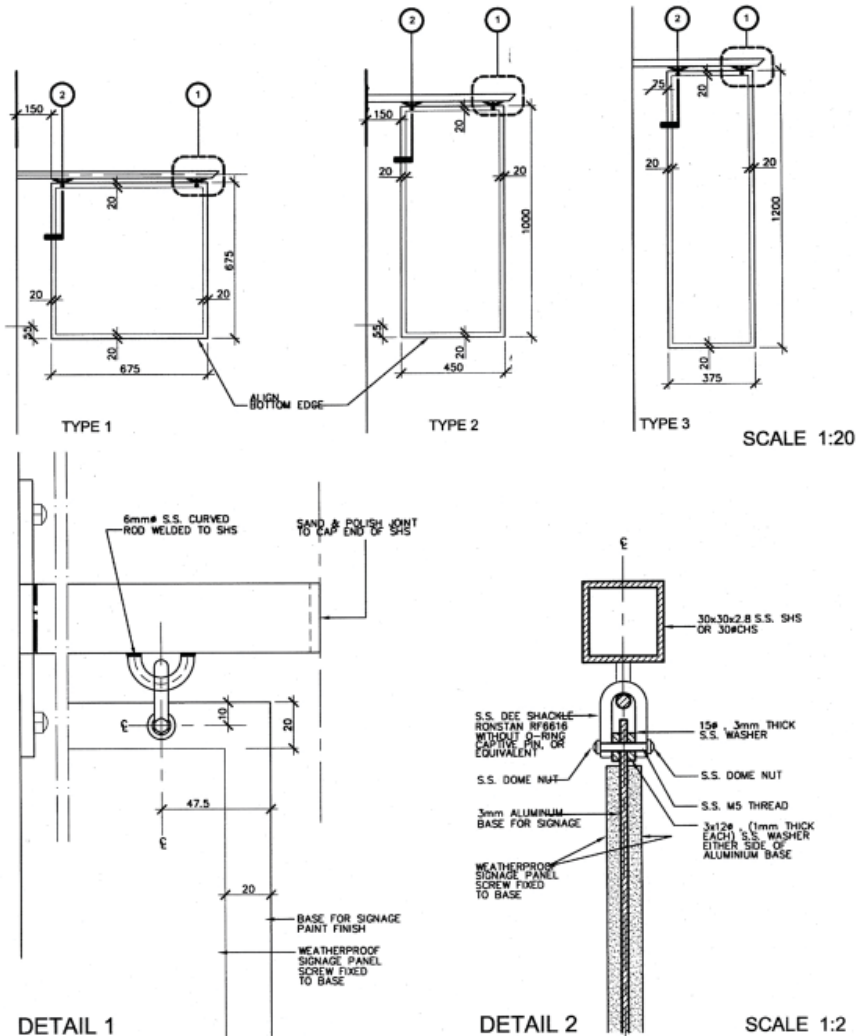





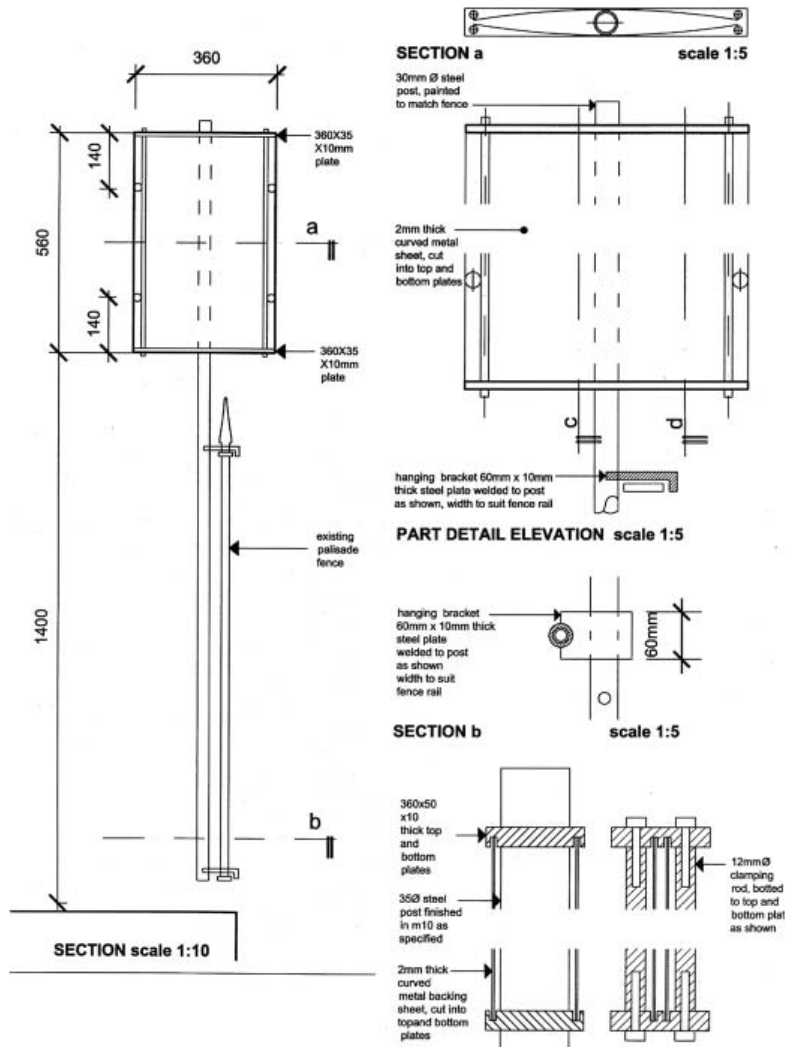



6.14

Specification Note 3



The Rocks signage precinct

Legend

-  A - Facades to narrow street, lanes & passages
-  B - Facades to wide streets
-  C - Terraces with party walls
-  D - Terraces, bald faced or with cantilevered balconies
-  J - Buildings over 6 storeys
-  K - Major multiple tenancy buildings
-  The Rocks signage precinct
-  Land excluded from this DCP

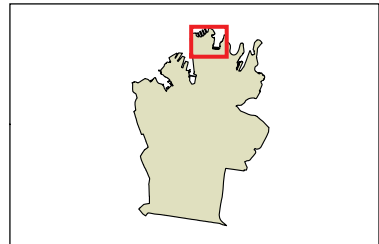

SIGNAGE IN THE ROCKS

	SIGN TYPES / APPLICATION MATRIX																										
	SHINGLE (SS1)	SHINGLE (SS1)	SHINGLE (SS3)	SHINGLE (SS4)	WALL PLAQUE (WP1)	WALL PLAQUE (WP2)	WALL PLAQUE (WP3)	PAINTED SIGN (PO1)	PAINTED SIGN (PO2)	PAINTED SIGN (PO3)	REMOVABLE PLACARD (RP1)	TRANSOM SIGN (TS1)	HAMPER SIGN (HS1)	WINDOW SIGN (SW1)	WINDOW SIGN (SW2)	SUSPENDED SIGN (SU1)	PAINTED FASCIA (PF1)	PAINTED FASCIA (PF2)	WALL PLAQUE (WP3)	MENU PLAQUE (WP4)	PROMO SHOP FRONT WINDOW (PW1)	REAL ESTATE (EXTERNAL) (RE1)	REAL ESTATE (WINDOW) (RE2)	RETAIL DIRECTORY (RD)			
A – Facades to narrow streets lanes and passages	•	•		•																							
B – Facades to wide streets			•			•																					
C – Terraces with party walls			•		•			•	•		•																
D – Terraces with cantilever balconies				•	•					•																	
E – Shop fronts												•	•	•													
F – Restaurant menus											•																
G – Removable /temporary							•				•				•						•		•				
H – Construction hoardings																											
I – Tall building signage																											
J – Major multiple tenancy buildings																											•

Schedule 7

Transport, parking and access

7.1

Introduction

The car parking rates in the LEP and DCP are based on access to public transport and services. A place that has a high level of access to public transport and services will need less car parking than a place that has a lower level of access to transport and services. Accessibility is categorised according to the following two indices:

- (a) 'PTAL' Index – the Public Transport Accessibility Level Index; and
- (b) 'LUTI' Index – the Land Use and Transport Integration Index.

Accessibility throughout the local government area has been mapped according to the PTAL and LUTI indexes. These maps are used to determine the maximum rates of car parking and are included in the LEP. It should be noted that where a development proposes less than the maximum number of car parking spaces, the total number of visitor spaces should be adjusted in accordance with this shortfall.

- (1) The PTAL Index:
 - (a) The PTAL Index applies to **non-residential development** and is based on the model developed by Transport for London to determine the level of access to public transport. Using data from Transport NSW and the Population Data Centre, the model identifies the public transport services, including trains, light rail, monorail, buses and ferries, within walking distance of a parcel of land. Each parcel of land is assigned an accessibility category based on the number of public transport services within certain walking distances.
- (2) The LUTI Index:
 - (a) The LUTI Index applies to **residential development** and combines access to public transport with access to urban centres, where residents can access neighbourhood services such as a range of shops. The LUTI Category is based on the walking distance to an identified urban centre from a parcel of land as well as the number of public transport services that are within walking distance of that parcel.

7.2

Managing transport demand

The DCP requires managing transport demand generated by a development to encourage more sustainable transport options. 'Managing transport demand' means minimising the need to travel, minimising the length of trips, (particularly by cars), and encouraging travel by more sustainable modes of transport (DIPNR, Integrating Land Use and Transport, 2001).

The detailed reports required for certain development applications (described below), provide the relevant information for Council assessment of transport impacts. They also identify the measures to be undertaken for a development to manage its transport demand.

7.3

Transport report requirements

The transport reports required to accompany a development application in accordance with Section 3.11 of this DCP are:

- (a) Transport Impact Study;
- (b) Parking and Access Report;
- (c) Green Travel Plan; and
- (d) Transport Access Guide.

7.4

Transport Impact Study requirements

A Transport Impact Study (TIS) is a technical investigation into the transport and safety issues that might arise from a development. The TIS includes the transport impacts on the surrounding transport network generated by a development and how those impacts are to be managed. In the past such studies have generally focused on traffic impacts however a TIS recognises the role of traffic within a broader transport system that includes public transport, walking and cycling.

A Transport Impact Study (TIS) is to address:

- (a) The accessibility of the site by a range of transport modes including car, public transport, walking and cycling;
- (b) The ability of the public transport network to service the site in the peak and off peak and weekend periods;
- (c) Mode share targets;
- (d) Means of minimising travel demand by private car and maximising the share of travel by other modes including public transport, cycling, walking or car share;
- (e) Compliance with the requirements of the LEP and DCP;

- (f) A justification of car parking provision and site servicing arrangements in accordance with the objectives and provisions of the LEP and DCP;
- (g) The proposed allocation of parking to apartment types in residential developments;
- (h) Access for the mobility impaired;
- (i) Estimates of trip generation by the development and the impacts of trips generated by the development on the road network and other movement systems;
- (j) Means of accommodating and integrating trips generated by the development including necessary improvements to public transport services, pedestrian systems, bicycle routes, and the road network;
- (k) Means of mitigating adverse impacts of the development on movement systems;
- (l) Means of improving access to the site having regard to vehicular, pedestrian, cycle and public transport access;
- (m) Impacts on and means of improving pedestrian accessibility to public transport, shops, schools, open spaces, community centres and the like. Means of improving access to public transport include the provision of subsidised public transport, improving the quality and safety pedestrian access to public transport, improving bus shelters and the like;
- (n) Impacts on and means of improving pedestrian safety;
- (o) Availability of on street parking and potential on street parking controls to discourage commuting and all day residential parking demand generated by the development..

Vehicle trip generation

In relation to vehicle trip generation, reference should be made to the 'RTA Guide to Traffic Generating Developments' which provides a summary of basic vehicular trip generating rates for both daily and peak hour vehicle trips. Surveys of existing developments similar to the proposal, can also be done and comparisons drawn.

Two periods of traffic generation need to be considered:

- (a) the peak activity time of the development itself
- (b) the peak activity time on the adjacent road network.

The peak activity time of the development is used as a basis for reviewing access to the site and driveway and access design requirements. The peak activity time of the adjacent road, pedestrian and public transport networks are used to assess the effect of the development on the road and other movement systems. Such an assessment should identify whether any on road improvements, traffic management or pedestrian measures are required to accommodate the increased movement on the system.

The Transport Impact Study is to include a comparison between the vehicle trip generation rates provide in the 'RTA Guide to Traffic Generating Developments' and an assessment that considers person trips by time period adjusted on availability of parking, access to public transport and access to neighbourhood shopping centre, community facilities and open spaces where relevant.

Adjustment factors for each land use may include:

- (a) mode split by time period;
- (b) persons per vehicle;
- (c) trip purpose; and
- (d) availability of on-site parking.

A number of traffic facilities can be incorporated to ameliorate the impact of traffic and parking generated by the development including traffic signals, signs, pedestrian crossings, channelisation, roundabouts, angled parking, traffic calming devices, storage bays and median islands.

Vehicle access

The Transport Impact Study is to include a description of the proposed vehicle access arrangements, and demonstrate that access driveways are not located in undesirable locations.

Bicycles

End-of-trip facilities such as storage, parking spaces, lockers and showers need to be provided in developments in accordance with the rates specified in this DCP.

Reference should also be made to the City of Sydney Cycle Strategy 2007-2017 and Planning NSW, 'Planning Guidelines for Walking and Cycling' (December 2004) and the NSW Bike Plan (May 2010).

Pedestrians

In relation to the pedestrian network, a Transport Impact Study is to include:

- (a) identification of major pedestrian routes and existing pedestrian desire lines;
- (b) pedestrian flows and potential conflicts with vehicles, particularly where such conflicts cause capacity constraint on either vehicular or pedestrian movement; and
- (c) pedestrian infrastructure.

The assessment of the pedestrian network should extend beyond the site to include areas within at least 25m of the subject site boundary, and incorporate both sides of roads within this zone.

A number of treatments for pedestrians are available to ameliorate the impact of developments by controlling pedestrian/vehicle interaction. These include time separated facilities, physical pedestrian aids, physically separated facilities and integrated facilities as defined within 'Austroads Guide to Traffic Management series and the Ausroads Guide to Road Safety series.

Reference should also be made to 'Planning Guidelines for Walking and Cycling', Department of Infrastructure, Planning and Natural Resources December 2004.

7.5

The requirements for a Parking and Access Report

A Parking and Access Report assists an applicant and Council in determining the appropriate provision of car parking spaces in a development. A parking and access report is required to accompany a development application where:

- (a) the schedules or tables in either the LEP or the DCP give no specific occupant or visitor car parking rates for a proposed development;
- (b) a development includes a mechanical parking installation; and/or
- (c) a development will generate trips by bus or coach.

7.5.1 Assessment of the appropriate provision of on-site car parking

Where a Parking and Access Report is required in order to assess the appropriate provision of on-site car parking, for a use that is not addressed in the LEP or DCP, it is required to address:

- (a) The appropriateness of the proposed location of the development having regard to the principles and location guidelines contained in the publication Integrating Land Use and Transport – Improving Transport Choice – Guidelines for Planning and Development published by the Department of Urban Affairs and Planning 2001; or
- (b) The site related requirements for location and access to facilities, in accordance with the requirements of State Environmental Planning Policy (Seniors Living) 2004 where development is for seniors housing.
- (c) The accessibility of the site by a range of transport modes including walking, cycling, public transport and car.
- (d) Ways of minimising travel demand especially by car and maximising the share of travel by other modes.
- (e) The specific nature of the development and method of operation including:
 - (i) maximum number of employees on the site at any one point and time, taking into account the number per shift and shift times;
 - (ii) estimates of the number of visitors to the site;
 - (iii) hours of operation;
 - (iv) the number of occasions during the year when the facility is fully used.
- (f) Parking requirements based on an analysis of the operational characteristics of the development and surveys of other similar development.
- (g) The anticipated demand for service and delivery vehicles.
- (h) The anticipated demand for bus coach and taxi set down and parking.
- (i) The availability and affordability of public parking.
- (j) The availability of additional parking areas to cover peak demands.
- (k) The assignment of traffic generated by the development to the road network and the prediction of operating conditions with and without the development.

7.5.2 Assessment of the appropriate provision for buses and coaches

Where the use proposed in a Development Application is a hotel, outlet store or other use that attracts persons arriving or leaving by bus or coach, the Parking and Access Report is to address:

- (a) the anticipated demand for bus/coach set down and parking;
- (b) routes likely to be used by buses/coaches to access the site;
- (c) pick-up / drop-off arrangements for bus/coach passengers;
- (d) parking arrangements for buses/coaches;

- (e) the likely path of pedestrian movement from the bus/coach drop-off and pick-up points and the entrance to the premises; and
- (f) assessment of possible conflicts between pedestrians, including bus/coach passengers; and
- (g) a description of measures required and proposed to ensure the safety of pedestrians, including bus/coach passengers.

7.5.3 Assessment of the appropriate provision for mechanical parking installations

An application that proposes a mechanical parking installation is to include a Parking and Access Report that demonstrates:

- (a) the overall parking provision will comply with relevant Australian Standards for off street car parking;
- (b) noise and vibration levels will be acceptable and in accordance with relevant standards;
- (c) there is safe pedestrian access at all times; and
 - (i) there is a management plan for its operation that is:
 - (ii) consistent with the manufacturer specifications;
 - (iii) implemented by trained personnel only; and
 - (iv) includes a system failure response.

7.6

Green Travel Plan requirements

Sustainable Sydney 2030 includes an action to promote sustainable travel behaviour by developing Green Travel Plans that will be implemented in new development. The DCP requires the preparation of a Travel Plan for development that is over a certain size. Preparing and implementing a Travel Plan is an important part of managing the transport demand generated by a development. The Travel Plan should be based on the findings of the Transport Impact Study. A Travel Plan aims to manage transport demand through a series of measures that promote and facilitate more sustainable modes of travel with a view to reducing private motor vehicle use.

The content of a Travel Plan will vary for each development depending on the proposed land use, characteristics of the development and the adjacent transport networks. Please refer to the "Workplace Travel Plan Resource" section of the Premiers Council for Active Living for guidance on preparing a Travel Plan (www.pcal.nsw.gov.au).

7.6.1 Monitoring and review mechanisms

In consultation with Council, the proponent should include the collection of baseline travel and mode split information gathered during the 6 months prior to construction of the development. If the development involves a change of use then the baseline travel information gathered during the previous month should be included. An on-going monitoring mechanism should be agreed with Council to ensure that annual performance reports are provided for an agreed number of years. Generally, the minimum number of years that the Council would require is 5 years.

The level of information to be provided by the proponent will be dependent on the scale of the proposed development. At a minimum all proponents should provide mode split proportions for the following modes (determined through a travel survey):

- (a) train;
- (b) bus;
- (c) bicycle;
- (d) walk;
- (e) car share;
- (f) motorcycle;
- (g) car (as passenger);
- (h) car (as driver);
- (i) shuttle bus (private and/or public service); and
- (j) other (including services associated with any Transport Management Association).

The annual reports should provide information on the number of person trips, travel modes by time of day, journey purpose and origin/destination of trips. The purpose of the monitoring is to assess the effectiveness of measures and to facilitate responsive actions to meet targets.

7.6.2 Implementation

The Travel Plan is to identify the position in the organisation responsible for implementing the plan. If responsibility lies with an organisation or company, a contact person, address and contact details should be provided. When the organisation or person to be responsible for the ongoing implementation of the Plan is unknown at the time it is prepared, the Plan should nominate a person or organisation who will be responsible in the interim period and outline process for transferring responsibility for ongoing implementation, such as by appointing a travel plan coordinator through a condition of a tenancy agreement.

7.7

Transport Access Guide requirements

The Roads and Traffic Authority (RTA) and the Sustainable Energy Development Authority (now the NSW Department of Environment, Climate Change and Water) developed Transport Access Guides so that organisations can contribute to a reduction in both green house gas emissions and traffic congestion by encouraging the use of more sustainable energy smart modes of transport.

The aim of a Transport Access Guide is to make sure people know how to get to the subject development by walking, cycling or public transport (as well as by car).

A Transport Access Guide can take many forms such as a map printed on the back of business cards or invitations to more comprehensive information provided to new staff as part of their induction kit. Guides may be incorporated into stationery, brochures and sales literature and provided electronically on the web site and in e-mails. An electronic version can be kept on a computer and produced as needed. Reception and enquiry staff should be familiar with the content so they can advise callers about easy transport alternatives to car travel.

Transport and Access Guides should be included in Green Travel Plans and should comply with RTA guidelines.

7.8

Required parking spaces and design

7.8.1 Service vehicles

- (1) The following minimum requirements for service vehicle parking apply to new development for:
 - (a) Residential buildings and serviced apartments:
 - (i) 1 space for the first 50 dwellings or serviced apartments; plus
 - (ii) 0.5 spaces for every 50 dwellings/serviced apartments or part thereafter.
 - (b) Commercial premises:
 - (i) 1 space per 3,300sqm GFA, or part thereof, for the first 50,000sqm; plus
 - (ii) 1 space per 6,600sqm, or part thereof, for additional floor area over 50,000sqm and under 100,000sqm; plus
 - (iii) 1 space per 13,200sqm, or part thereof, for additional floor area over 100,000sqm.
 - (c) Shops, shopping centres:
 - (i) 1 space per 350sqm GFA, or part thereof, up to 2,000sqm; then
 - (ii) 1 space per 8,00sqm GFA thereafter.
 - (d) Hotels:
 - (i) 1 space per 50 hotel bedrooms, or part thereof, up to 100 bedrooms; then
 - (ii) 1 space per 100 hotel bedrooms; plus
 - (iii) 1 space per 400sqm of reception, lounge, bar and restaurant area GFA, or part thereof, for the first 2,000sqm; then
 - (iv) 1 space per 8000sqm of reception, lounge, bar and restaurant area GFA thereafter.
 - (e) Industry, warehouse, distribution centre:
 - (i) 1 space per 700sqm GFA, or part thereof.
 - (f) Other uses:
 - (i) 1 space for 1,750sqm GFA, or part thereof, or to meet needs.
- (2) For mixed use developments, the total number of service vehicle spaces is to be calculated on a pro rata basis of spaces required for the relative proportions of different uses within the building.
- (3) The total requirement identified in (1) above may be reduced for developments with GFAs in excess of 50,000sqm where it can be demonstrated to the satisfaction of the consent authority that:
 - (a) the proposed uses are complementary in terms of servicing demand; and
 - (b) at least one space per tenancy for business owners is provided.

7.8.2 Buses and coaches

- (1) Parking for buses and coaches is to be provided at the following minimum rates for:
 - (a) Clubs, Drive-in Takeaway with seating:
 - (i) 1 bus/coach* space per 100 seats up to 200 seats, then 1 space per 200 seats thereafter;
 - (b) Reception Premises:
 - (i) 1 bus/coach* space per 200sqm GFA up to 200sqm, then 1 space per 400 sqm GFA;
- (2) Provision for tourist coach parking in conjunction with hotels is to take into account available off-site coach parking. Where practicable, and subject to urban design, heritage and streetscape considerations, loading and unloading of passengers and baggage is to be accommodated within the development site.

7.8.3 Passenger pick up and set down areas

- (1) Hotels, Motels and Serviced Apartments:
 - (i) 2 car spaces plus;
 - (ii) 1 bus/coach* space per 100 rooms where the development comprises 100 rooms or more.
- (2) Child Care Centres:
 - (i) car spaces at the rate of 1 space per 8 children, and limited in duration to no more than 30 minutes at any one time. Pick-up and set down spaces may be reduced having regard to the demand for pick-up and set down parking, accessibility by walking and public transport, the availability of convenient and safe on-street parking and potential traffic and amenity impacts; and
 - (ii) 1 long term visitor car parking space which is additional to all other parking requirements.

Note: The City of Sydney only gives development consent. Applicants/proponents should contact the childcare regulator to determine their specific requirements for outdoor space.

7.8.4 Motorcycle parking spaces

- (1) In all buildings that provide onsite parking, 1 motorcycle parking space for every 12 car parking spaces is to be provided as separate parking for motorcycles. Each motorcycle parking space is to be designated and located so that parked motorcycles are not vulnerable to being struck by a manoeuvring vehicle.

7.8.5 Accessible car parking spaces

- (1) One accessible car parking space is to be provided for every adaptable residential unit.
- (2) One space for every 20 car parking spaces or part thereof is to be allocated as accessible visitor parking.

TRANSPORT, PARKING AND ACCESS

- (3) Accessible parking is not required in a car parking areas where a parking service is provided and direct access to any of the car parking spaces is not available to the general public or occupants.
- (4) For residential development, accessible car parking spaces are to be allocated to adaptable units, or as visitor parking. Accessible car parking spaces allocated to adaptable dwelling units are to be a part lot to an adaptable unit in the strata plan.
- (5) Accessible parking is to be designed in accordance with the requirements of relevant Australian Standards.

Schedule 8

Tree management

8.1

Neighbour notification

- (1) Notification of neighbours is required when a tree included in Council's Register of Significant Trees is proposed to be removed. Only neighbours adjoining the property are to be notified.

8.2

Arborist reports

- (1) An **Aboricultural Impact Assessment Report** is required with all development applications that may impact on trees. This report is to also assess trees located within adjoining properties (including street trees) where they may be impacted by the proposed works.
- (2) When an application is received for the pruning or removal of a tree located on private property, the Council may require a **General Arborist Report** to be submitted for assessment.
- (3) Arborist Reports are to be prepared by an arborist with a minimum qualification of Diploma of Horticulture (Arboriculture) Australian Qualification Framework (AQF 5) or equivalent, and with demonstrated experience in high level tree assessment and diagnosis.

8.2.1 Aboricultural Impact Assessment Report

- (1) The procedures in Australian Standard for the Protection of Trees on Development Sites (AS4970) are to be followed when preparing an Aboricultural Impact Assessment Report.
- (2) In preparing an Aboricultural Impact Assessment Report:
 - (a) removal can not be recommended for any tree that is located on adjoining properties (including Council land) unless written consent from the tree owner is obtained; and
 - (b) recommendations for tree removal are to be based on arboricultural findings only. Removals where the reason given is to permit the proposed development will not be accepted.

8.2.2 General Arborist Report

- (1) A General Arborist Report is to:
 - (a) state the name, business address, telephone number of company;
 - (b) provide evidence of technical qualifications and experience of the arborist, who undertakes the tree inspection, diagnoses and prepares the report;

TREE MANAGEMENT

- (c) identify the address of the site containing the trees;
- (d) identify the name of the person or company for whom the report is prepared;
- (e) establish the methods or techniques used in the inspection;
- (f) identify and include correct botanical and common names of all trees included in an application to prune or remove trees on private land; or undertake a visual assessment of each tree, outlining the following information:
 - (i) the tree species (Botanic & Common Name) of each tree;
 - (ii) the approximate height, canopy spread and trunk diameter of each tree;
 - (iii) an assessment of the health and condition of each tree, including a general description of the age class, form and habit, evidence of previous pruning, presence of disease or pest infestation and evidence of structural defects or damage;
 - (iv) an estimate the remaining Safe Useful Life Expectancy of each tree;
 - (v) an assessment findings in a tree schedule/table appended to the report; and
 - (vi) a record of the tree assessment with evidence that it is prepared in accordance with industry best practice.
- (g) include a suitably scaled plan of the site showing the location of all trees assessed in the report;
- (h) include a colour photograph of each tree and/or group of trees discussed within the report;
- (i) include a summary or discussion of other relevant tree and site specific information such as soil and drainage characteristics, pests and diseases and tree hazard assessment details;
- (j) provide supporting evidence such as annotated colour photographs, internal diagnostic testing, laboratory results or aerial inspection findings.
- (k) provide a discussion of all options available, including why tree works are recommended or not recommended,
- (l) provide recommendations on the tree's future management. In the event that pruning is recommended, the pruning specification is to be specified in relation to Australian Standard for the Pruning of Amenity Trees (AS4373.)
- (m) include the sources of technical information referred to in the report. (References not used in the report should not be included); and
- (n) present information as objectively as possible without attempting to advocate for the client.

Schedule 9

Green roofs and walls

9.1

Introduction

Green roofs and walls have been used throughout the world as a remedy to increasing urban density and a lack of access to green and open space. In April 2014 Council adopted the *Green Roofs and Walls Policy* which supports increasing the installation of quality green roofs and walls in the local government area. More information about Green Roofs and Walls can be found on the City's website.

If you are installing greenery on your building, the technology and designs exist to provide a well-functioning, beautiful addition to your building.

Plants can be:

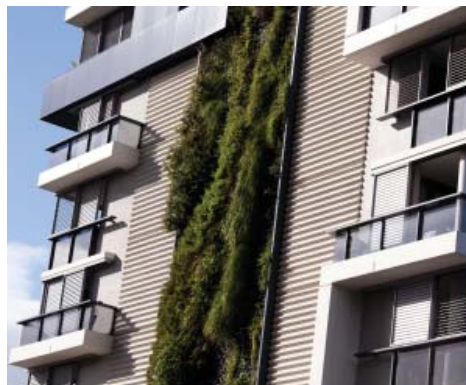

integrated into the walls



used as a standalone feature



provide significant open space



or a small private area

Whatever your site constraint – greenery can be integrated into your building design in a way that creates a more beautiful space and adds value to your building and to the environment.

The City of Sydney encourages the inclusion of green roofs and walls into the urban fabric. Green roofs and walls are not only beautiful, but also provide many benefits to the City including:

- creating additional space for urban greening, food production and private open space;
- slowing and cleaning stormwater;
- reducing the impacts of the urban heat island effect;
- improving air quality;
- improving amenity and liveability;
- increasing the absorption of carbon dioxide;
- increasing habitat to support biodiversity;
- improving building efficiency through heating, cooling and sound insulation;
- providing places for passive and active recreation and social interaction;
- improving the efficiency of solar panels; and
- extending roof life.

The integration of plants into building design is essential to improve the City's resilience to increasing population density and to a changing climate..

9.2

Definitions

Green roof means a roof where vegetation covers at least 30% of available rooftop space, that is, space which is not occupied by structures housing plant, equipment or stairway accesses. A green roof should provide measurable environmental benefits to the City of Sydney. The green roof includes a vegetated layer, growing medium, drainage layer and a waterproof membrane. Plants grown in sectioned lots are acceptable, however, potted plants/planter boxes which cover less than 30% of available rooftop space are not considered as a green roof. Additional to the minimum 30% vegetation cover, a green roof can include facilities for renewable energy, water collection infrastructure, walkways, furnishings and the like.

Green wall means walls that are either free-standing or part of a building that is partially or completely covered with vegetation. The wall may incorporate soil and/or inorganic material as the growing medium. There are two main types of green wall, including:

- green façades, that are made up of climbing plants either growing directly on a wall or on specially designed supporting structures. The plant's shoot system grows up the side of the building while being rooted in the ground; and
- living walls, with modular panels are affixed to the wall and geo-textiles, irrigation and a growing medium combine to support a dense network of plants.

9.3

Design considerations

This section is to provide general guidance on a number of design factors that require consideration when incorporating a green roof and/or wall into a development. Professional advice should be sought when considering the specific design, installation and maintenance requirements for your green roof or wall.

Access	Consider access to the green roof or wall for installation and maintenance purposes. Considering access early will determine how the green roof or wall is to be installed and maintained over time and can potentially reduce ongoing costs.
Accessibility	If a green roof is to be accessible to all, consideration will need to be given to pathway widths and planter box depths in order to ensure the design is free of trip hazards and can be readily accessible to residents in wheelchairs or with low mobility.
Biodiversity	Where possible, your green roof or wall design should incorporate plants from the immediate Sydney area. This is particularly important to support biodiversity. For green roofs, the inclusion of ponds or water features will also encourage bird and invertebrates to use the space. Insect hotels, rockeries and designs that provide hiding spaces for invertebrates will also support local biodiversity. Including plants that flower at different times of the year will also encourage bees and support a healthy garden.
Drainage	A drainage layer will be required to ensure water drains away from the roof adequately. For shallow (extensive) profile green roofs it is recommended that a cup style drainage layer be employed to help keep moisture in the system and prevent plants from drying out. For a deeper (intensive) soil profile a more free flowing drainage layer is more appropriate to minimise weight on the roof. Additional layers of coarse sand can be employed above the drainage and filter fabric layers to further improve drainage.
Food	Residents are increasingly looking to grow their own food and roof and wall spaces can provide opportunities for urban food production. Growing food on your building reduces food miles, provides a source of fresh food as well as opportunities to socialise and gain skills. If you are considering growing food the minimum soil media depth should be 450mm to ensure good growth. Irrigation is essential to integrate into the garden beds or green walls. If you are growing food on a wall, then plants with shallow rooting systems are preferable (herbs, lettuces, strawberries, spinach etc).
Noise pollution	Where green roofs are going to be used regularly as outdoor space it should be designed to minimise noise impact on neighbours. Screening plants and layered plantings will help to minimise noise.
Privacy	Whilst supporting green roofs, the City is also mindful of not impinging on the privacy of others. Roof tops that overlook other private spaces may require the installation of privacy screens and plantings.
Safety	Where a green roof is to be used as open space, the Building Code of Australia (BCA) requires adequate safety measures be employed to ensure the safe use of the space. If the green roof is not trafficable or used as open space it will still require a system to allow maintenance personnel to safely access the roof. If the green roof is to be used as an open space, a parapet or guarding to BCA standards is required to all edges.
Slope	A green roof requires a slope of at least 2° to ensure proper drainage. If the roof is completely flat, drainage layers can be added to improve drainage on the roof. Green roofs can be installed on roofs of pitches of 40° or more, however pitches of less than 30° are preferable to minimise soil erosion. Green roofs over 10-15° may require added support to keep soil and plants evenly distributed on the roof.

Soil media	<p>The soil used for green roofs and walls needs to be specialist mixes that are both light weight and provide sufficient structure to allow plants to grow and drain water effectively. This DCP requires minimum soil media depths to ensure plant growth is maintained. <i>Lower soil depths may be acceptable if Council is satisfied it is appropriate to the location and use.</i></p> <p>Once soil is installed on your roof or wall it should be watered in to allow the soil to settle. Once planted out, a thick layer of mulch (75mm) should be added to prevent soil erosion and to reduce watering requirements. Over time soil and fertilisers will need to be added to your roof garden or green wall to ensure the soil media and plants are kept healthy.</p>
Solar access	<p>In order for your green roof or wall to flourish, consideration needs to be given to the site aspect. Plants should be selected that thrive in the particular sun and wind conditions of your site. If you are intending to grow food on your green roof or wall, maximising daily sun exposure is essential.</p>
Sound insulation	<p>Soil in green roofs dampens low frequency noise and the plants dampen high frequency noise. Research has shown that a 200mm layer of substrate on a green roof can reduce sound by 46-50 decibels. For best effects the soil media and plants should cover the maximum surface area of the roof.</p>
Solar panels	<p>Green roofs improve the efficiency of solar panels and can be integrated into solar PV systems. Evapotranspiration from plants helps to keep temperatures cooler and at an optimal level for solar panels to function efficiently.</p>
Species selection	<p>Plants should be selected that are appropriate and can thrive in the local conditions. Consider sun access and the potentially higher wind impacts of plants on roofs or on busy road corridors. The City encourages the use of local and drought tolerant species. Species lists are available from the City and include plants that are known to do well on green roofs and walls.</p>
Water / irrigation	<p>Irrigation is important to maintain the health of plants. It will not need to be used consistently once plants are established, however it is an important design feature to ensure plants are kept alive during extremely hot days. Keeping moisture up to the plants also provides additional cooling of the building through evapotranspiration. Sub-surface drip irrigators are preferred as they direct moisture to the plant roots without wastage. Above ground irrigation or spray irrigation can lead to water spray drift into public areas and should be avoided. Irrigation from rainwater harvesting, or from treated grey or black water is encouraged.</p>
Waterproofing	<p>Green roofs are able to extend the life of waterproofing by more than 20 years. The inclusion of soil and plants limits direct sun and wind exposure to the water proofing membrane, and keeps temperatures more consistent – thus preventing expansion and contraction of water proofing as the roof heats and cools. It is recommended that testing of the integrity of the water proofing be carried out before the green roof is installed. Additional leak detection systems can be installed with the green roof, which allow even small penetrations in the water proofing to be located.</p>
Weight	<p>All green roofs and walls must be assessed to ensure the weight of the structure is suitable for the building. The saturated weight of a green roof can vary from 90Kg per square metre for a shallow profile up to 200 – 500Kg per square metre for deeper or more intensive planting. A structural engineer will need to assess your green roof or wall design to ensure your building can tolerate the additional load.</p>
Wind	<p>Plants, furniture and other objects installed on a roof space are subject to much higher wind conditions than at ground level. When designing and installing a green roof, safety measures against wind uplift need to be considered. Furniture, shade structures, planters and soil all need to be designed to withstand windy conditions.</p>

9.4

Information required to be submitted with a development application

Where a development application is required, the following information should be submitted for the consideration of Council:

- (1) A detailed plan of the green roof, drawn to scale, by a qualified landscape architect or landscape designer. The plan must include:
 - (i) A statement that includes details of proposed use of the green roof, general accessibility, any noise and privacy treatments.
 - (ii) Location of existing and proposed structures, services and hard landscaping on the rooftop, retaining walls, and roof fixings and other structural elements that may interrupt waterproofing, including cross-sectional details of all components.
 - (iii) Details of the location, sizes and numbers of plants used with reference to NATSPEC (if applicable), with preference for drought resistant local species.
 - (iv) Details of substrate type and depth.
 - (v) Details of installation methodology e.g. safety considerations for working at height, transport of materials etc.
 - (vi) Details of accessible and inaccessible areas on the Green Roof. Where proposed to be inaccessible, Green Roofs are required to remain such during occupation of the property.
 - (vii) Details of drainage and irrigation systems, including overflow provisions.
- (2) Prior to the issue of a Construction Certificate, a Maintenance Manual is also to be submitted.

Schedule 10

Providing community infrastructure in Green Square

10.1

Introduction

This schedule details how key community infrastructure is to be delivered in the Green Square Urban Renewal Area (Green Square) under clause 6.14 *Community infrastructure floor space at Green Square* of *Sydney LEP 2012* and section 5.2.3 *Community Infrastructure* of this DCP.

This schedule excludes reference to the Green Square Town Centre as the Town Centre is excluded from *Sydney LEP 2012* and this DCP.

The purpose of this schedule is to:

- explain why community infrastructure is important for the regeneration of Green Square and why it is needed to support redevelopment;
- describe how the community infrastructure can be delivered through the development process and planning agreements; and
- outline how the value of the community infrastructure works is calculated.

10.2

Why is community infrastructure needed in Green Square

Green Square is strategically located between the City, Sydney Airport and Port Botany, and continues to offer the opportunity for large scale regeneration of former industrial lands. This regeneration will significantly contribute to the City of Sydney meeting its dwelling and job targets set by the NSW Government.

Green Square is to become an attractive, vibrant and sustainable urban place that is well served by the appropriate level of infrastructure. The Green Square population is expected to grow substantially – by 2030 it will be home to over 50,000 residents and about 22,000 people are expected to work there.

To accommodate this growth and to ensure the successful transformation of Green Square, substantial new infrastructure is needed. In particular, the provision of new public streets, pedestrian and bike links, parks, community facilities and stormwater management, will ensure successful sustainable regeneration and a high level of amenity.

Some of the community infrastructure can be funded and delivered through developer levies under the *City of Sydney Section 94 Contributions Plan 2006* (the Section 94 Plan), as updated or replaced from time to time. The Section 94 Plan identifies some key works to be delivered within Green Square such as the major new transit corridors and public open spaces. However, the scope of the Section 94 Plan is not sufficient to fund all the infrastructure necessary to support the scale of redevelopment planned in Green Square. The City has additionally committed significant funds to deliver these works and other facilities.

The community infrastructure needed in Green Square cannot be provided by the City alone, despite its access to Section 94 contributions. A partnership approach with the developer for the delivery of this infrastructure is therefore necessary, and allowing development additional floor space where appropriate in return for the provision of additional infrastructure is key to the successful growth of Green Square.

10.3

Defining community infrastructure

Community infrastructure is defined in *Sydney LEP 2012*. The provisions under section 5.2.3 of this DCP lists in more detail the works that make up community infrastructure. Other provisions under section 5.2.4 Green Square of this DCP further identify the location where some of these works may be provided with development to match community infrastructure floor space.

In general, community infrastructure refers to civil infrastructure, public domain and physical facilities that support the built environment and benefit the population within the immediate vicinity of a site as well as the wider Green Square population. For example, by providing new roads the accessibility and permeability of an area increases for pedestrians, cyclists, cars and public transport. Landscape setbacks as an extension to the road reservation can offer a green buffer to development fronting the road, whilst they can provide a pleasant walking and cycling experience for the wider community, and a habitat corridor for plants, insects and birds.

Critically, *Sydney LEP 2012* requires that the infrastructure is to be “reasonably necessary” for Green Square and of a certain value. Refer to section 10.4 of this Schedule.

It should be noted that the community infrastructure is that which is over and above the requirements of the Section 94 Plan, and is in addition to any requirements for improvements that may arise from consideration of a development application by the consent authority under Section 79C of the *Environmental Planning and Assessment Act 1979*.

10.4

How is the appropriate community infrastructure identified

The Floor Space Ratio (FSR) Map under *Sydney LEP 2012* identifies the maximum FSR permissible for a site. Clause 6.14 of the LEP specifies the maximum additional FSR (above that shown in the FSR Map) that a site may potentially achieve if “equivalent” community infrastructure is included with the development. Clause 6.14 further defines “equivalent” community infrastructure.

The development must be acceptable in terms of environmental capacity and compliance with development controls, must contribute to the desired character of its locality, and must have little or no impact on the amenity of the locality. Therefore, the development must be acceptable on a merit assessment before the City can agree to a package of community infrastructure associated with the development.

The proposed community infrastructure is to be acceptable to the City and should meet the social, physical and environmental vision for Green Square. It is to be of an appropriate value that is to be calculated as set out in section 9.5 of this schedule.

If an applicant seeks to access additional FSR under clause 6.14 of *Sydney LEP 2012* and provide community infrastructure, the following is required:

- ensure the site is eligible and establish the additional FSR potentially achievable by checking clause 4.4 *Floor Space Ratio* and the relevant FSR Map, and clause 6.14 *Community infrastructure floor space at Green Square of Sydney LEP 2012*;
- ascertain the community infrastructure that may be required to achieve the additional FSR by checking section 5.2 *Green Square* of this DCP; and
- if appropriate, identify other community infrastructure that may be offered as part of the total package of public benefits.

If there is no physical community infrastructure that may be provided within a site, the additional FSR may still be potentially achieved if the applicant proposes to contribute towards the delivery of other community infrastructure off the site but within Green Square.

The City may collect monetary contributions for identifiable works. However, with the exception of contributions for the Green Square Town Centre, the City will seek as far as practicable that community infrastructure works (rather than monetary contributions) are undertaken.

If an applicant seeks to access the additional FSR it is strongly advised that a pre-lodgement meeting be arranged with the City's planning officers.

10.5

How is the value of the “equivalent” community infrastructure assessed

Clause 6.14 of *Sydney LEP 2012* establishes that development, to be eligible for additional FSR must include “equivalent” community infrastructure. Amongst other things, to be “equivalent”, the community infrastructure is to be of a certain cost.

The City uses a dollar rate to establish the minimum cost so that it is equivalent to the additional floor space being achieved under clause 6.14. The intent is to ensure an equitable and transparent assessment of the public benefits that may be derived from the provision of community infrastructure by an applicant.

The total dollar value of the community infrastructure package is calculated based on the type of use and amount of additional floor space proposed under clause 6.14 of *Sydney LEP 2012*. The dollar rates per square metre of additional floor space are as follows:

Residential floor space	\$475 per square metres (excl. GST)
Retail floor space	\$275 per square metres (excl. GST)
Other non-residential floor space	\$200 per square metres (excl. GST)

Note: The City of Sydney adjusts the above rates from time to time.

As part of the community infrastructure package a rate of \$100 per square metres (excl. GST) is included as a monetary contribution towards the Green Square Town Centre. As the Town Centre will have flow on benefits for the wider Green Square, including improved land values, this monetary contribution is allocated towards the delivery of the Town Centre essential infrastructure. This monetary contribution applies to all land uses and is included within the total value calculated.

The following steps summarise the process to establish the community infrastructure package:

- **Step 1** – the applicant calculates the total dollar value of the additional floor space using the above rates (excluding any design excellence floor space)
- **Step 2** – the City and the applicant identify the community infrastructure works to be provided and their priority, including the monetary contribution towards the Green Square Town Centre essential infrastructure
- **Step 3** – the City and the applicant establish the total cost of the identified community infrastructure works to be delivered by the applicant within the site and/or within the Green Square locality (the cost is established by a quantity surveyor)
- **Step 4** – the total cost of the works to be delivered by the applicant and the Town Centre monetary contribution are deducted from the total dollar value of the additional floor space calculated in Step 1 above, to work out the difference, if any, between the cost of works and the total value of the additional floor space
- **Step 5** – the City and the applicant review and adjust the scope of works to prioritise the delivery of works
- **Step 6** – where applicable, and if the City considers appropriate, where the total cost of works identified in Step 3 above, is less than the value of the additional floor space, the City may agree to a monetary contribution towards capital works projects being delivered by the City within Green Square

Where the additional floor space proposed is less than 100 square metres, the provision of community infrastructure may not be applied.

10.6

How is the commitment to provide community infrastructure secured

The legal instrument that sets out the applicant's offer to deliver community infrastructure in association with development is the planning agreement. The offer is made voluntarily by the applicant so as to access additional floor space potentially achievable under clause 6.14 of *Sydney LEP 2012*. The *Environmental Planning and Assessment Act 1979* and the *Environmental Planning and Assessment Regulation 2000* define a planning agreement and set out how it is to be prepared and finalised.

Both the City and the applicant must come to a mutual agreement on the appropriateness of the community infrastructure package. The details of this package are incorporated into a planning agreement

The chart overleaf outlines the process for the preparation of a planning agreement. The process shown is only indicative, and may vary depending on the nature of the planning agreement being prepared.

Planning agreement process for community infrastructure



Schedule 11

Electronic variable content advertising structures

11.1

Guidelines for a Visual Impact Assessment report

A visual impact assessment report is a technical investigation of the visual impact that a development will have on the public and private domain compared to existing conditions. The visual impact assessment will assist in qualifying the reasonableness of the visual impact on existing and future views.

A visual impact assessment report should be prepared by a qualified urban planner, urban designer, architect or landscape architect with expertise in visual impact assessment.

For large-format electronic advertising structures, a visual impact assessment report is to include:

- (1) A clear description of the existing site (built form, land uses, site features, etc), the proposed advertising structure and its visual characteristics. This includes (but is not limited to) physical appearance, size, location, lighting, hours of operation, dwell time, transition times, display specifications and other operational attributes;
- (2) A clear description of the character and visual attributes of the area within proximity of the proposed advertising structure. This includes (but is not limited to) buildings, structures, other signs, important view corridors, important visual features, visually enhancing or detracting features, heritage, other existing and proposed developments, weather conditions, solar access and shadows;
- (3) Review of other technical reports and management plans relating to the advertising structure. This should include (but is not limited to) light impact, road safety, heritage and operational management plans;
- (4) Review of all relevant planning framework documents. This is to include state environmental planning policies (including State Environmental Planning Policy 64), the Sydney Local Environmental Plan 2012, the Sydney Development Control Plan 2012 and Australian Standards;
- (5) A context plan that maps and photographs the existing character of the area surrounding the proposed advertising structure. This is to include (but is not limited to) specific viewing points, view sheds and any items of visual interest;
- (6) An assessment of the significance, visibility, impact and reasonableness of public, driver and private views of the proposed advertising structure in comparison to existing conditions. This is to be undertaken by:
 - (a) Identifying and mapping locations where views will be assessed from (view assessment locations). View assessment locations are to be key public domain, vehicular access and private domain locations where the advertising structure will be visible from. The view assessment locations are to relate to prominent views in the locality and must be representative of the surrounding public and private environment. View assessment locations should be determined through pre-development application discussions with City of Sydney;

- (b) Taking daytime and night time photography of the site from all view assessment locations to visual express the context of the proposed advertising structure. All photographs are to be undertaken by a professional photographer, use camera settings that best represent the human eye and have the camera location recorded by a surveyor. The specifications for photography are to be determined through consultation with the City's Modelling Unit. Survey and MGA coordinates are to be based on Established Marks registered in the Department of Lands and Property Information's SCIMS Database with a Horizontal Position Equal to or better than Class C;
- (c) Prepare photomontages and/or computer simulations of the proposed advertising structure from each of the view assessment locations for comparison with photographs of the existing visual environment. The specifications for photomontages are to be in accordance with the guidelines prepared by the NSW Land and Environment Court;
- (d) Prepare a written summary of each existing view from the view assessment location. This is to include the distance from the view assessment location to the point of interest, the character of the view assessment location and the amount of activity at the view assessment location (including time of day);
- (e) Prepare a written assessment of both existing and proposed views of the site in relation to:
- (i) Significance of Existing Views
- 'Significance of Existing Views' measures the importance of existing views from a view assessment location. The significance is to be determined by:
- whether the view contains features such as (but not limited to) landmarks, iconic buildings, vegetation, water, land-water interface or countryside;
 - whether the view is static, moving, open or enclosed;
 - the amount of activity in the space at various points in time;
 - the length of time that the space is used for; and
 - the overall quality of the built environment.
- 'Significance of Existing Views' is to be assessed using a scale ranging from 'Negligible Significance' to 'High Significance'. The criteria for determining the score is to be clearly identified and explained.
- (ii) Potential Visibility
- 'Potential Visibility' assesses how likely the proposed advertising structure is to be seen from the view assessment location. The potential visibility of an advertising structure is to be determined by factors such as (but not limited to):
- the distance between the advertising structure and the view assessment location;
 - how elevated the view assessment location and/or advertising structure is;
 - the number of potential viewers at the view assessment location and the duration of the users view;
 - whether the proposed advertising structure will be a primary or secondary feature of the view;

- the relationship the advertising structure has with other features in the view; and
- the operational attributes of the advertising structure (such as brightness, dwell time and transition time).

'Potential Visibility' is to be assessed on a scale, ranging from 'No Visibility' to 'High Visibility'. The criteria for determining the score is to be clearly identified and explained, having regard to the number of potential viewers, the duration of the view and the time of day.

(iii) Impact on View

'Impact on View' is an assessment of the extent of change that the proposed advertising structure has on the quality of the view from the view assessment location. 'Impact on View' is to take into account factors such as (but not limited to):

- 'Potential Visibility' and the extent to which the proposed advertising structure will restrict views to key view features;
- how the design and visual attributes of the proposed advertising structure responds to the view and whether it fits within the existing visual context;
- whether the proposed advertising structure enhances or detracts from the view;
- the impact that the advertising structure has on existing light conditions (particularly at night time or in dark environments); and
- the impact of its operational attributes (such as variable content and transition times) on the character of the area.

'Impact on View' is to be assessed on a scale, ranging from 'No Impact' to 'Severe Impact'. The criteria for determining the score is to be clearly identified and explained.

(iv) Acceptability of View Impact

'Acceptability of View Impact' assesses whether the overall 'Impact on View' that the advertising structure has is beneficial, acceptable or unacceptable.

The 'Acceptability of View Impact' is to be determined having regard to (but not limited to):

- the assessment of 'Significance of Existing View', 'Potential Visibility' and 'Impact on View' against the existing and desired character of setting where the advertising structure is proposed; and
- whether this satisfies the relevant planning objectives for the area.

The 'Acceptability of View Impact' is to be assessed and rated as either 'Beneficial', 'Acceptable', 'Acceptable through mitigation measures', or 'Unacceptable'. If the 'Acceptability of View Impact' cannot be determined, additional investigations must be undertaken.

Certain proposals may be required to provide additional information as identified by the consent authority.

- (7) The findings and conclusions of the view impact assessment are to be presented in the report. The report is to make recommendations to ensure the proposed advertising structure does not detract from the quality of the existing visual environment. Measures to mitigate any negative visual impacts may include (but are not limited to) changes to the siting and location, changes to colours and materials, reduction in size, changes to design, reduced illumination, longer dwell times, limited hours of operation or screening.

Resources: *Tenacity Consulting Pty Ltd v Waringah [2004] NSWLEC 140*

Rose Bay Marina Pty Ltd v Woollahra Municipal Council & Anor [2013] NSWLEC 1046

Landscape Institute, IEMA – Guidelines for Landscape and Visual Impact Assessment (2013)

Smardon, Palmer & Felleman – Foundations for Visual Project Analysis (1986)

Land & Environment Court Photomontage Policy (2013)

11.2

Guidelines for a Light Impact Assessment report

A light impact assessment report is a technical investigation into light intensity and light trespass issues that may arise from illuminated development.

For large format electronic advertising structures, a light impact assessment report is to assess the light impact that the structure will have on the public and private domain. The assessment will consider the light intensity and light trespass relative to existing conditions, statutory requirements and the provisions of this DCP. The assessment will make recommendations to ensure that illumination associated with the advertising structure will not create unacceptable glare, will not result in a safety impact for public domain users and will not reduce the amenity of accommodation land uses, particularly at night.

A light impact assessment report is to be prepared by a qualified lighting engineer, and is to address:

- (1) The existing and desired character of the area of locality;
- (2) The location of the light source and any environmental conditions that will influence its operation and performance, such as (but not limited to) overshadowing from other development and existing vegetation;
- (3) The technical specifications of the light source, including (but not limited to) size, direction, materials, maximum light output, ability to adjust brightness, light distribution, maintenance and surface reflectance;
- (4) The impact that the illumination will have on adjoining land uses, in particular residential accommodation and other land uses providing overnight accommodation;
- (5) The impact that the illumination will have on lighting in the public domain;
- (6) The impact that illumination will have on motorists, cyclists and pedestrians;
- (7) The cumulative illumination from light sources in the locality;
- (8) Recommendations for maximum luminance and curfews to ensure compliance with this development control plan; and
- (9) Recommendations for on-going compliance.

- (10) The calculation of illuminance, luminance and threshold increment is to be determined in accordance with Section 5 of AS 4282-1997 and the following:
- (a) Significant reduction in the luminous flux occurs during the life of the lamp, primarily as a result of a gradual depreciation in light output and an accumulation of dirt on the transmitting or reflecting surfaces of the luminaires. In order to replicate a worst case installation, a Maintenance Factor of 1 is to be used for the calculations.
 - (b) For the purpose of calculation, the area is to be considered free of trees, vehicles and any other similar obstructions.
 - (c) Calculations of 'Illuminance and Luminance on Vertical Plane' is to be carried out on all surrounding properties.
 - (d) Calculations of 'Threshold Increment' are to be a series of points in both directions of traffic and for all lanes. The calculation grids are to be in the centre of the lane with maximum 5m spacing and at a minimum distance of 100m from the advertising structure.

Resources: *AS/NZS 1158 – Lighting for roads and public spaces*

AS 4282-1997 – Control of the obtrusive effects of outdoor lighting

Notes: *AS/NZS1158 – Lighting for roads and public spaces applies to the lighting of roads and other outdoor public spaces. It covers lighting schemes for roads, pedestrians and outdoor public spaces.*

The series provides recommendations on the illuminance requirements for the lighting design of pedestrian and road lighting, based on anticipated traffic volume, crime rate and the importance to highlight prestige. It also details the brightness limitation of exterior light sources.

AS/NZS1158 is only applicable to general lighting that is providing functional/safety movement lighting to the public space and does not specifically applying to outdoor advertising signage.

However the objective of road lighting is to provide a lit environment that is conducive to the safe and comfortable movement of vehicular and pedestrian traffic at night and the discouragement of illegal acts, while protecting the integrity of the night time environment through control of light spill and glare.

The standards do not specifically address illuminated signs and their impact on the road users. But as care should be taken that glare to pedestrian and motorists is reduced, the Standard is applied as a best practice to confirm that an advertising sign is not providing circulation lighting to the pathway. However the illuminance target in this series is not applicable to advertising signs.

AS/NZS4282-1997 – Control of the obtrusive effects of outdoor lighting specifically refers to the potentially adverse effects of outdoor lighting on nearby residents (e.g. of dwellings such as houses, hotels, hospitals), users of adjacent roads (e.g. vehicle drivers, pedestrians, cyclists) and transport signalling systems (e.g. air, marine, rail), and on astronomical observations. The Standard includes recommended benchmarks for:

- (a) *illuminance (amount of luminous flux arriving a site boundary/ residential window);*
- (b) *luminous intensity (the perceived brightness of the signage); and*
- (c) *threshold increment (the potential glare that may affect the transport system).*

AS/NZS4282 does not apply to:

- (a) *public lighting (lighting provided for the purposes of all-night safety and security on public roads, cycle paths, footpaths and pedestrian movement areas within public parks and garden);*
- (b) Internally illuminated advertising signs;
- (c) The obtrusive effects of brightly lit surfaces, e.g. floodlit buildings, and externally lit advertising signs.

Although AS/NZS4282 specifically excludes internally illuminated signage (as per Section 1.1 Scope b & c of the standard), in the absence of any other specific regulation or standard to minimise impact of illuminated signs on nearby residential properties, the standard is applied as best practice to confirm compliance of a sign, advertisement or advertising structure's night time operation against the recommended brightness levels in the Standard.

Table 2.1 of AS/NZS4282 recommends design benchmarks based on the surrounding environment a building element is located within. An assessment of the location and its context is required to determine the appropriate criteria applicable for this assessment.

In addition, Threshold Increment Limits apply at all times where users of transport systems are subject to a reduction in the ability to see essential information. Values given are for relevant positions and viewing directions in the path of travel. Compliance with this requirement will ensure there is no temporary visual impairment of drivers who view the signage. Table 2.1 of AS/NZS4282 notes the specific maximum value for this assessment.

11.3

Measurement of Luminance

The measurement of luminance following commencement of the advertising structure's operation is to be undertaken as follows:

- (1) In order to maximise the area recording in a single reading, measurements shall be made with a luminance meter that has a field of view up to 10 degrees with an Acceptance Angle of 1 degree.
- (2) Measurements are to be undertaken so that no ambient (dark or bright) background area or spurious light source outside or beyond the illuminated area of the advertising structure is included in the field of view of the luminance meter.
- (3) The measurement of luminance is to be taken with the operator standing on the edge of the travelled way in a direct line and at a predetermined horizontal distance from the advertising structure. The horizontal distance (x) from an advertising structure is based on the largest axis dimension (a) of the advertising structure, and shall be determined from the following formula:

$$(x) = 5 \text{ multiplied by } (a) \text{ metres}$$

- (4) A series of measurements are to be undertaken and the worst (brightest) result recorded to determine the worst case (brightest) luminance level for the entire sign face.
- (5) The luminance meter used for the measurement shall have a current certificate of calibration.

11.4

Times for daylight hours, twilight hours and night time hours by calendar month

When determining daylight hours, twilight hours and night time hours for the purpose of assessing compliance with Section 3.16.7.2(4) of this DCP, the following times are to apply:

Month	End of Night Time Hours / Start of Twilight Hours (AM)	End of Twilight Hours (AM) / Start of Daylight Hours	End of Daylight Hours / Start of Twilight Hours (PM)	End of Twilight Hours (PM) / Start of Night Time Hours
January	5:30	6:00	20:00	20:30
February	6:00	6:30	19:30	20:00
March	6:30	7:00	19:00	19:30
April	6:00	6:30	17:30	18:00
May	6:15	6:45	17:00	17:30
June	6:30	7:00	16:45	17:15
July	6:30	7:00	17:00	17:30
August	6:15	6:45	17:15	17:45
September	5:30	6:00	17:30	18:00
October	5:45	6:15	19:00	19:30
November	5:15	5:45	19:30	20:00
December	5:15	5:45	20:00	20:30

Source: Adapted from Time and Date AS (2015)

Note: *All times are inclusive of daylight saving*

All times are in 24-hour format

11.5

Guidelines for a Road Safety report

A road safety report is a technical investigation into the impacts a proposed development will have on the safety of users of an adjoining road corridor. A road safety report is to be prepared by a qualified transport engineer.

For large format electronic advertising structures, a road safety report is to consider the extent to which the structure is likely to obstruct the view of motorists and cyclist's view of the road and/or traffic control devices, cause conflict with driving tasks at intersections and other decision points, cause distraction or be a physical obstruction.

A road safety report is to consider and address:

- (1) A clear description of the existing site, including (but not limited to) built form, land uses and site features;
- (2) A clear description of the proposed advertising structure. This includes (but is not limited to) its physical appearance, size, location, brightness, hours of operation, technical specifications, dwell time and transition time;
- (3) The location of the structure and its visibility. This should include any environmental conditions that will influence its visibility, including (but not limited to) daylight, overshadowing from other development and presence of existing vegetation;
- (4) Detailed analysis of adjoining and surrounding road network, including (but not limited to) traffic volumes, speed limits, intersections and decision points, cyclist and pedestrian infrastructure and crash data;
- (5) Compliance with relevant environmental planning instruments and other planning controls. This is to include relevant state environmental planning policies (such as State Environmental Planning Policy 64 and the Transport Corridor Outdoor Advertising and Signage Guidelines, including section 3), the Sydney Local Environmental Plan 2012, the Sydney Development Control Plan 2012 and Australian Standards; and
- (6) Recommendations and means of mitigating adverse impacts of the advertising structure on the adjoining road network. This may include changes to the siting and location, changes to dwell time and transition time, changes to colours and materials, reduction in size, changes to design, reduced illumination, restricted hours of operation (including a curfew) and/or screening.

Schedule 12

Procedures for demonstrating compliance with variation provisions for street frontage height and setbacks, side and rear setbacks, building separations and tapering controls in Central Sydney

Relevant sections of the DCP are reproduced below for ease of reference.

Minimum Street Frontage Height and Street Setbacks

Section 5.1.1.1

- (1) The Street Frontage Height and Street Setbacks of a building must be in accordance with Table 5.1 – Permissible range of Street Frontage Heights and Table 5.2 Minimum Street Setbacks, except for buildings in Special Character Areas that must be in accordance with the Minimum Street Frontage Heights for Special Character Areas in Table 5.3, and the Minimum Street Setbacks and Maximum Street Frontage Heights as shown in the Special Character Area maps at Figures 5.4 to 5.16 in Section 5.1.1.2.
- (3) Where noted in Table 5.2 Minimum Street Setbacks and on the Special Character Area maps, variation to Street Setbacks may be permitted to building massing that provides:
 - (a) encroachment(s) 2m forward of the minimum Street Setback within the middle third of the frontage to a Public Place and provision of compensating recess(es) of equal to or greater area up to 4m behind the minimum Street Setback; or
 - (b) equivalent or improved wind comfort, wind safety and daylight levels in adjacent Public Places, relative to a base case building massing with complying Street Frontage Heights and Street Setbacks (i.e. variation to massing is governed by achieving equal or better performance).

Procedures for demonstrating compliance with 5.1.1.1(3)(a) and (b) are set out in Schedule 12.

Side and Rear Setbacks and Building Form Separations

Section 5.1.1.6

- (6) Variation to Side and Rear Setbacks and Building Form Separations may be permitted to building massing that provides equivalent or improved wind comfort, wind safety and daylight levels in adjacent Public Places, relative to a base case building massing with complying Side and Rear Setbacks (i.e. variation to massing is governed by achieving equal or better performance).

Procedures for demonstrating compliance with 5.1.1.6(4) are set out in Schedule 12.

Note: Building massing includes all building elements at all levels. For example fins, external sun shading devices, architectural features, screens, signs, awnings etc

Built form massing, tapering and maximum dimensions

Section 5.1.1.4

- (3) Above the Street Frontage Height the total Building Envelope Area may occupy the following proportion of the site area less any areas of heritage items and required DCP setbacks:
- 100% up to 120m above ground;
 - 90% above 120m up to 240m above ground; and
 - 80% above 240m above ground.

12.1

Procedure A:

Minimum Street Setback Encroachment and Compensating Recess

In order to demonstrate compliance with Section 5.1.1.1(3)(a) in regards to varying Minimum Street Setbacks, the following procedure must be followed:

- (1) Building massing with a frontage to a Public Place, where each frontage is assessed independently at each floor, the building may encroach up to a maximum of 2m forward of the required Minimum Street Setback within the middle third of the frontage if it provides an equal or greater area of compensating recesses up to 4m behind the Minimum Street Setback, but not within any other required setback.

Figure 12.1.1

Setbacks provide building design flexibility – Minimum Street Setbacks may only be varied in accordance with Section 5.1.1.1(3) of the DCP and the procedures for demonstrating compliance. This diagram shows area where encroachments and compensating recess(es) may occur

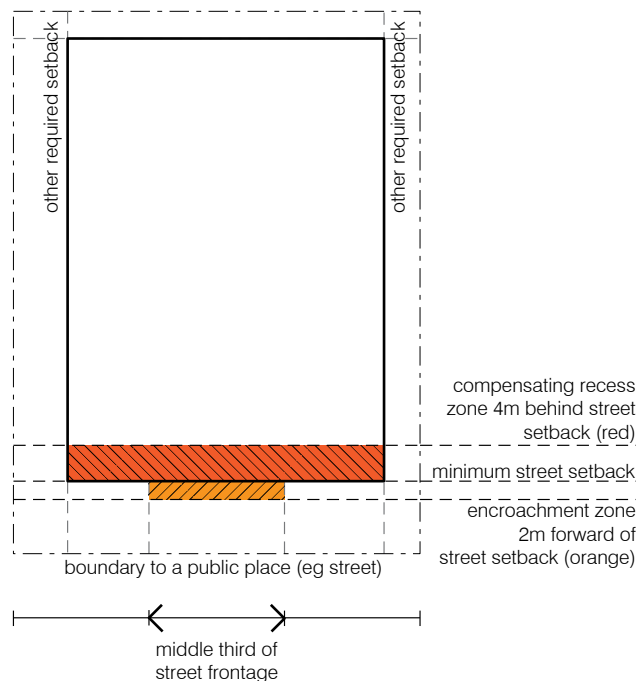
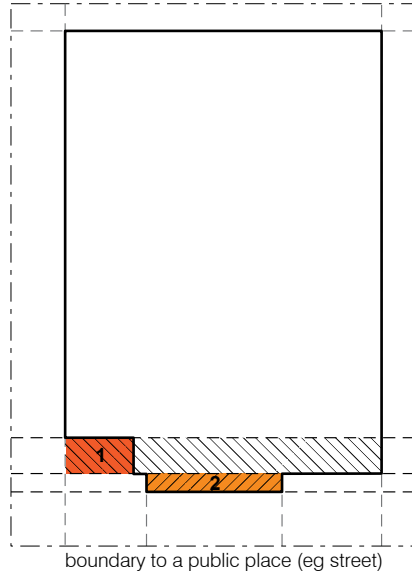
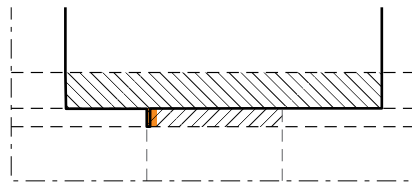

Figure 12.1.2
 Example showing area of compensating recess (1) equal to area of encroachment (2)



- (2) Some encroaching elements have a larger impact on daylight to a Public Place than is directly reflected in their plan area. For the purposes of assessing the area of such small or tightly spaced elements like architectural fins, any encroachments are deemed to have an area equal to their plan area except elements less than:
 - (a) 1m wide – where they are treated as if they are 1m wide; and

Figure 12.1.3
 Example showing a narrow fin less than 1m wide within the encroachment zone - the deemed area of the encroachment shown orange has equal depth and is 1m wide



- (b) 3m apart – where they are treated as if they are a single element that has a plan area extent described by joining the element's outermost edges with straight lines.

Figure 12.1.4
 Example showing 2 narrow fins less than 3m apart within the encroachment zone – the deemed area of the encroachment shown orange includes the space between the encroaching elements

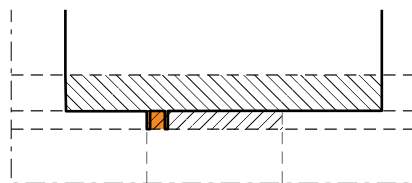

- (3) Some recesses will have a negligible or limited benefit to daylight levels in Public Places so an area of building recess will only be deemed to be a compensating recess if it is:
 - (a) at least 3m wide (see example at "*" in Figure 12.1.5 which is not 3m wide so is not a compensating recess);

Figure 12.1.5

Example showing a slot that is not 3m wide (at the asterisk) – this is not deemed to be a compensating recess because it is too narrow to provide any daylight benefit

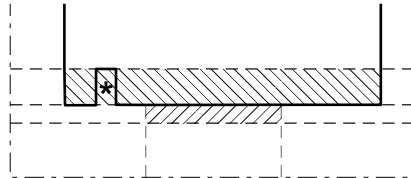

- (b) wider than it is deep (ie no narrow slots [see example at "A" in Figure 12.1.6 which is wider than it is deep so is a compensating recess, where as "B" in Figure 12.1.6 is deeper than it is wide so is only a compensating recess for that portion of the recess equal to its width]); and

Figure 12.1.6

Example showing two recesses that are both 3m wide – recess A is wider than it is deep so the full area shown red is deemed a compensating recess, recess B is deeper than it is wide so only an area with a depth equal to the width shown red is deemed as an area of compensating recess

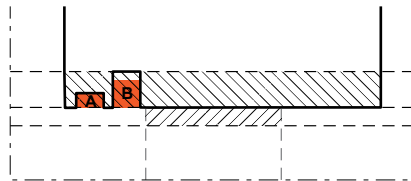

- (c) is clear to the sky for the full height of the building.
- (4) Notwithstanding 3(a) and (b) above, the full area of a building recess contiguous with any other required setback (other than the relevant street setback) is a compensating recess.

Figure 12.1.7

Example showing a narrow deep recess that is contiguous with a required side setback – the full area shown red is deemed a compensating recess

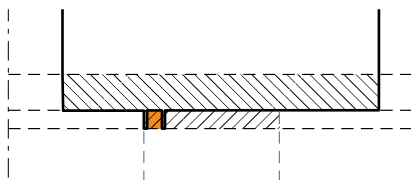

- (5) On corner sites, the compensating recesses for each frontage are assessed independently of each other. That part of a recess that complies with the criteria for both street frontages may be counted as compensation toward encroachments on each frontage.

12.2

Procedure B:

Equivalent or improved wind comfort and wind safety and daylight levels in adjacent Public Places

Procedure B can only be used for sites larger than 1000m².

Procedure B is used for demonstrating compliance with Section 5.1.1.1(3)(b) and Section 5.1.1.3(6) in regards to varying Minimum Street Setbacks, Side and Rear Setbacks, Street Wall Height, Building Form Separations and Tapering provisions.

A base case model is prepared which meets all the requirements set out for Procedure B. The base case model is tested to establish the minimum performance benchmarks for daylight levels (or sky view factor) and wind comfort and safety in public places adjacent to the site. The alternative building envelopes are tested for equivalence with these performance benchmarks.

The base case model and proposed alternative building envelopes are tested, with the results of this performance benchmark equivalence testing used to demonstrate that the proposed alternative envelopes perform better than the base case in relation to daylight levels (or sky view factor) and wind performance. This informs the suitability of proposed variations to the setbacks, street wall height, building form separation and tapering controls in relation to measurable daylight (or sky view factor) and wind performance.

The base case model envelope is not a “complying envelope” for future development on a site. Any proposed building envelope needs to demonstrate that a high quality urban design outcome will be achieved through the preparation of a detailed urban design and options analysis that demonstrates how the proposed massing is compatible with the context, and is in accordance with all the relevant controls within the LEP and DCP (including Division 4 of the LEP for design excellence) .

The base case model, with complying street frontage heights, setbacks, building separation and tapering controls, comprising a podium and tower component (in terms of area and volumes), is a 3-dimensional model to be prepared, tested and reported as follows:

- (1) Podium Component Volume:
 - (a) for part(s) of a site occupied by heritage items or forming part of the curtilage of a heritage item: reflect the existing height and form of the existing building or provide open curtilage to the heritage item.
 - (b) for parts of the site within a Special Character Area: extrude to the lower of the heights nominated on the Special Character Area map and in Table 5.3.
 - (c) for other parts of the site:
 - (i) where the building envelope is up to 120m high – extrude the part of the site vertically 35m above existing ground level (as it varies around the site perimeter);
 - (ii) where the building envelope is more than 120m high – extrude the part of the site vertically 25m above existing ground level (as it varies around the site perimeter).

Note: Where both (i) and (ii) are applicable to the site, the podium height is based on the height of the building envelope at the point above.

- (2) Tower Component Area:
- (a) apply the required minimum street, side and rear setbacks, and building separations in Section 5.1.1.1(1) and Section 5.1.1.3(2) of the DCP.
 - (b) do not include areas over heritage items or the curtilage of a heritage item, and Tower Component areas narrower than 6m wide.
 - (c) All external corners of the Tower Component are to be chamfered with a circular radius that removes an area in square metres at each corner equal to the maximum horizontal dimension of the Tower Component Area \times 0.4 (see illustration) up to a maximum of 20m² or a radius of 10m. Where corners are close together each chamfering operation is to be considered independently to determine the appropriate radius, i.e. the areas to be removed may overlap. If a part of the Tower Component is too narrow to chamfer its corners individually with a single radius, that part's corners may be treated together using a single radius that removes the sum of the areas required to be removed, e.g. for a rectangular part of the Tower Component that is 7m wide where the chamfering is required to remove 20m² at each of two external corners a 3.5m radius chamfer could be used but located in such a way as to remove 40m² of the Tower Component Area).

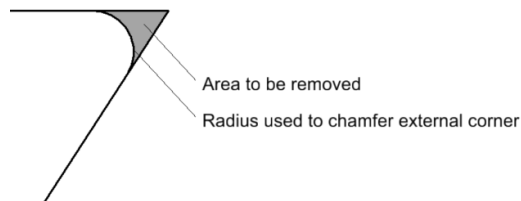

- (3) The Tower Component Volume:
- (a) extrude the Tower Component Area to the maximum permissible building height as it varies around the site.
 - (b) The extruded Tower Component Volume must be tapered by scaling it horizontally in both horizontal directions (X and Y) by:
 - (i) 95% (for the portion of the tower between 120-240m above ground level) which is equivalent to a 90% area relationship.
 - (ii) 90% (for the portion of the tower greater than 240m above ground level) which is equivalent to an 80% area relationship.

Figure 12.1.8
 Defining the base case tower component area and building massing

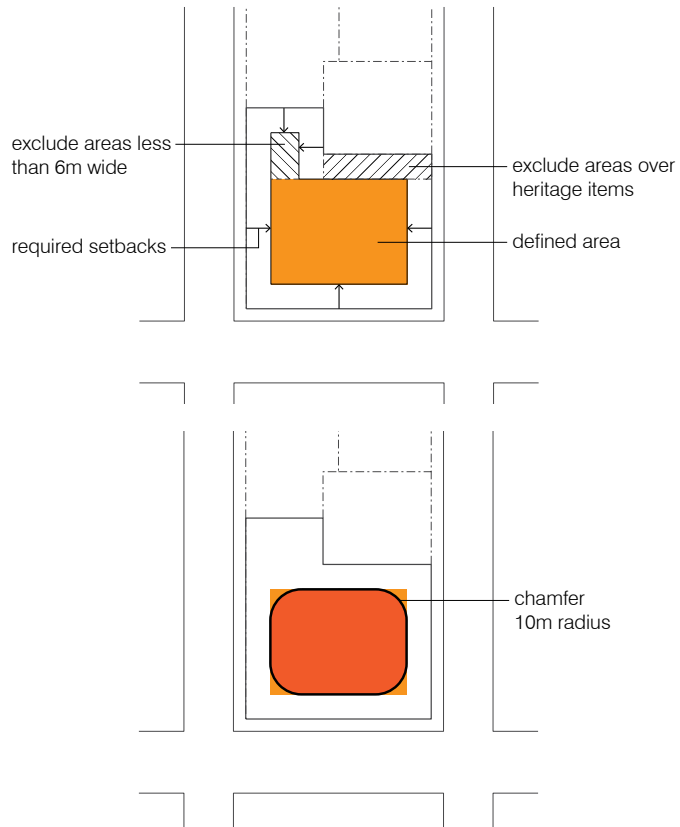
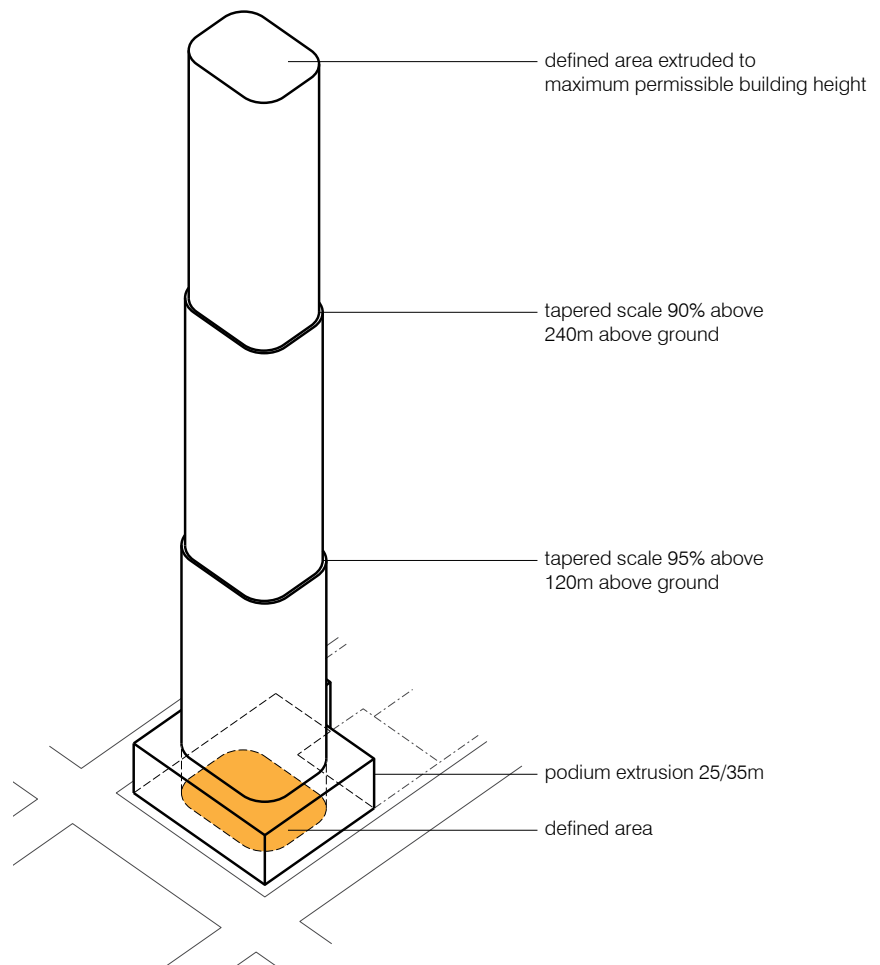

Figure 12.1.9
 Tapering the base case tower building massing



Note: the maximum permissible building height excludes architectural roof features (i.e. no additional height should be assumed for permissible architectural roof features) but includes all other relevant controls including LEP height controls, Sun Access Planes, No Additional overshadowing Controls, Special Character Area height and setback controls, View Controls Airport restrictions etc.

(4) Model Testing

The wind and daylight testing of the base case model and alternative building envelopes are to include measurements in public places for a distance of at least 50m and no more than 100m from the site boundary. The tests must exclude any elements within a Public Place (e.g. trees and awnings) and must satisfy the following requirements for wind and daylight (or sky view factor):

- (a) Wind: wind speeds are defined by Section 5.1.9 Managing Wind Impacts, Sydney DCP 2012 for comfort and safety.

Wind speeds must be measured within the existing city form and be distributed evenly across the surrounding public places and include testing locations in areas where wind speeds are likely to change as determined by a wind report.

- (b) Daylight Factor: the average annual daylight level (which may be approximated by the average Sky View Factor) and should be measured on a 1m grid.

- (i) Daylight Factor is the percentage of available daylight, on a daily basis, throughout the year.

Daylight Factor is weighted by the daily availability of light (assuming an open environment), to account for variations in amount of light throughout the year, rather than an average annual quantum of daylight.

To calculate the Daylight Factor: simulate the available direct and diffuse illuminance that reaches the ground level of the adjacent public places each day for a typical year for the base case and alternative building envelopes and express them as daily percentages of the maximum available daylight in an equivalent open environment for each day. The daily percentage factors are then averaged to give a single Daylight Factor value for each option. These Factors can then be compared.

The daylight calculations are to include consideration including the directionality of sunlight, diffuse daylight access, seasonal weather variation, and typical luminance variation of the sky.

- (ii) Sky View Factor (SVF) is the extent of sky observed above a point as a proportion of the total possible sky hemisphere above the point.

SVF is calculated as the proportion of sky visible when viewed from the ground (as an abstract horizontal surface) up. SVF is a dimensionless value that ranges from 0 to 1. A SVF of 1 denotes that the sky is completely visible to the horizon in all directions; for example, in a flat terrain. When a location has topography or buildings blocking view to any part of the sky, it will cause the SVF to decrease proportionally.

Because SVF measures the whole sky hemisphere and only a small fraction of the sky will be subject to change as part of a development the SVF must be resolved at a high resolution to detect the change. This is an inherent feature of the SVF measure. This means that the sky must be subdivided into more than 5000 equal areas for final SVF calculations but also that the difference in SVF may appear small particularly when averaged over a large area.

Figure 12.1.10

Sky View Factor means the extent of sky observed above a point as a proportion of the total possible sky hemisphere above the point

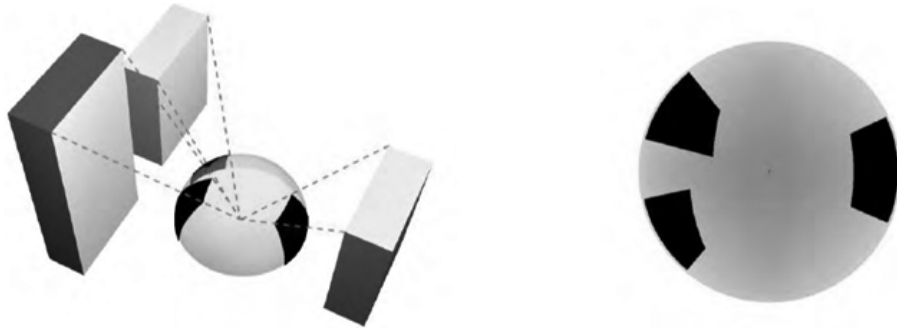

(5) Equivalence reporting

All data that is relied on for equivalence testing must form part of the report including individual data points as tables and model geometries for the base case and alternative building envelopes. These must be described with sufficient dimensions to allow for the equivalent model to be created by a third party for checking.

- (a) For wind: the 5% exceedance comfort wind speed values in metres per second must be averaged and compared. The comfort categories are not relevant in demonstrating equivalence.

Note that the proposed alternative building envelopes must both demonstrate equivalence and also not cause wind speeds that exceed comfort or safety standards or cause worsening of existing exceedances.

- Note: if the equivalence testing shows new or worsened exceedances of the comfort or safety standards, additional wind tunnel testing will be required to show how these exceedances can be mitigated. This testing may include modelling of awnings consistent with DCP requirements.

- (b) For daylight (or SVF): the factors are averaged and the single resultant values compared.

In this document “equivalent” wind speed and daylight/SVF is to be understood as very slightly “better than” at a high level of accuracy. For example a SVF of 0.10001 is equivalent to a SVF of 0.10000 by being very slightly better than it.

Authors of equivalence reports must note that while daylight and wind equivalence is essential, any proposal must still be supported by a detailed urban design and options analysis to demonstrate that a high quality urban design outcome will be achieved, and the proposed massing is compatible with the context.